

ALUMINCO®

A ALUMINIUM BUILDING SYSTEMS

DOOR
PANELS

catalogue
2013



Περιεχόμενα | Index

Προφίλ εταιρείας Company profile	2-3
Ευρετήριο σχεδίων Design index	4-7
P100 Series	8-27
Inox Series	28-51
E2000 Series	52-107
P6000 Series	108-125
AL590	126-127
Ταμπλαδάκια Special size panels	128
FP20 Aluplast / PVC	129
Χειρολαβές Handles	130-131



Η ALUMINCO, με έδρα τα Οινόφυτα Βοιωτίας, είναι η πρώτη εταιρία στον κλάδο που από την ίδρυσή της ξεκίνησε με την παραγωγή προϊόντων από καυτό αλουμίνιο πάνω σε παραδοσιακά μοτίβα. Σήμερα, αξιοποιώντας 31 χρόνια εμπειρίας στον χώρο, έχει μετεξελιχθεί σε μια ολοκληρωμένη, κάθετη βιομηχανία αλουμινίου. Στο κέντρο παραγωγής της διατηρεί ολοκληρωμένες μονάδες επεξεργασίας, ηλεκτροστατικής βαφής, μοντάζ, φινιρίσματος, συσκευασίας και αποθήκευσης των προϊόντων που παράγει και παραδίδει.

Η ALUMINCO προσφέρει σύγχρονες αρχιτεκτονικές και κατασκευαστικές λύσεις με βάση το αλουμίνιο, στις οποίες περιλαμβάνονται:

- Πλήρης σειρά ανοιγόμενων και συρόμενων συστημάτων αλουμινίου, ψυχρών και θερμομονωτικών.
- Πληθώρα σχεδίων σε πάνελ αλουμινίου για κάθε αρχιτεκτονική και κατασκευαστική ανάγκη με έμφαση στην αισθητική, τη λειτουργικότητα και την ασφάλεια.
- Πόρτες ασφαλείας και θωρακισμένες πόρτες για κύριες εισόδους επαγγελματικών ή ιδιωτικών κτιρίων. Διατίθενται σε παραδοσιακό ή σύγχρονο στυλ, σε μεγάλη ποικιλία σχεδίων και χρωμάτων.
- Συστήματα καγκέλων για μπαλκόνια, βεράντες και σκάλες. Σε παραδοσιακά και μοντέρνα σχέδια, από καυτό αλουμίνιο, προφίλ αλουμινίου ή τύπου inox συνδυασμένα με πολυκαρμονικά φύλλα.
- Συστήματα εξωτερικών χώρων όπως πέργκολες, αίθρια, στέγαστρα εισόδων, αυλόπορτες, αυλόγυροι και φωτιστικά, προσφέροντας ολοκληρωμένες λύσεις στην κατασκευή κτιρίων υψηλών απαιτήσεων.

Με εξαγωγική δραστηριότητα σε πάνω από 60 χώρες σε όλο τον κόσμο, η ALUMINCO είναι προσπλωμένη στον τομέα της συνεχούς έρευνας και ανάπτυξης προϊόντων που ανταποκρίνονται ποιοτικά, αισθητικά και λειτουργικά στις απαιτητικές και ταχύτατα εξελισσόμενες αγορές.

Η διαδικασία βαφής των προϊόντων της βασίζεται στις προδιαγραφές QUALICOAT και SEASIDE CLASS (επεξεργασία παραθαλάσσιας κλάσης) ενώ τηρεί σύστημα διαχείρισης ποιότητας κατά ISO 9001 και σύστημα περιβαλλοντικής διαχείρισης κατά ISO 14001.

Όλα τα συστήματα αλουμινίου και καγκέλων σχεδιάζονται, αναπτύσσονται και δοκιμάζονται στο τμήμα Έρευνας & Ανάπτυξης της εταιρείας και στη συνέχεια πιστοποιούνται από αναγνωρισμένα ινστιτούτα και διεθνείς οργανισμούς όπως το IFT Rosenheim Γερμανίας, το Istituto Giordano Ιταλίας, το ΕΚΑΝΑΛ (Ελληνικό Κέντρο Ανάπτυξης Αλουμινίου) Ελλάδα κ.α.

Η ALUMINCO οδηγεί τις εξελίξεις στον τομέα του αλουμινίου, αναβαθμίζοντας συνεχώς τις υπηρεσίες και τα προϊόντα που προσφέρει, με ολοκληρωμένες λύσεις που καλύπτουν τις ανάγκες της σύγχρονης κατασκευής και βελτιώνουν την ποιότητα ζωής δημιουργώντας σχέσεις εμπιστοσύνης με τον τεχνικό κόσμο και το καταναλωτικό κοινό.



ALUMINCO, situated in Inofita (40km from Athens & 70km of the int. airport EL. BENIZELOS), Viotia, is the first company of this sector that, since its establishment, begun the production of items made of cast aluminium on traditional patterns. Today, with 31 years of experience, our company has evolved to an integrated vertical aluminium industry. The production center includes integrated processing units, units of powder coating, assembling, finishing, packaging and storage.

ALUMINCO offers aluminium-based modern architectural and constructive solutions, which include:

- A complete series of tilt & turn sliding and thermal break aluminium systems.
- Several series of on aluminium panels for any architectural and building need, emphasizing on aesthetics, functionality and safety.
- Safety doors and reinforced doors for main entrances of any building. Available in traditional or modern styles, in a large variety of designs and colors.
- Railing systems for balconies, verandahs and stairs. In traditional and modern designs, of cast aluminium or inox type combined with polycarbonate panels.
- Outdoor systems, such as pergolas, patios, entrance canopies, yards and lighting, offering integrated solutions for buildings of high demands.

Our exporting experience to more than 60 countries throughout the world, keeps ALUMINCO dedicated to product research and development, satisfying the qualitative, aesthetic and functional needs of the demanding and rapidly developing markets.

The powder coating procedure is based on QUALICOAT specifications for SEASIDE CLASS; our company conforms to the quality system ISO 9001 and the system of environmental management ISO 14001.

All aluminium and railing systems are designed, developed and tested by the department of Research & Development and then are certified by recognized institutes and international organizations, such as IFT Rosenheim of Germany, Instituto Giordano of Italy, EKANAL (Greek Center of Aluminium Development of Greece), etc.



ΚΑΤΑΛΟΓΟΣ ΠΕΡΙΕΧΟΜΕΝΩΝ ΜΕ ΔΙΑΣΤΑΣΕΙΣ ΣΧΕΔΙΩΝ

P100 Series

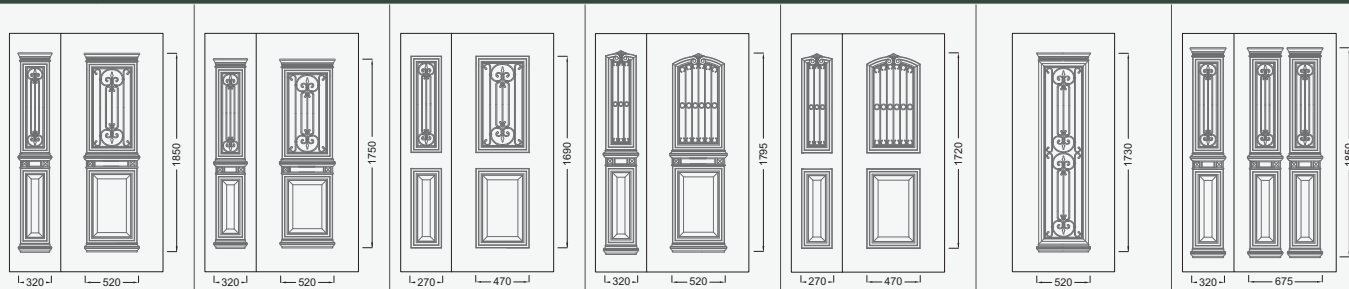

P105-P100 Pg.12-13

P105K-P100K Pg.27

P106-P101 Pg.10-11

P115-P110 Pg.16-17

P116-P111 Pg.16

P124 Pg.13

P105-P130 Pg.14

I300 Series

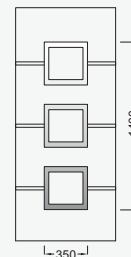
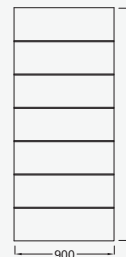
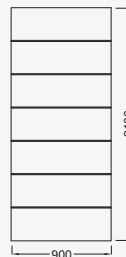
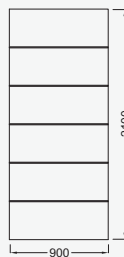
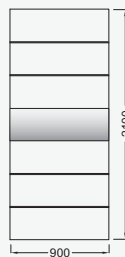

I221 Pg. 33

I224 Pg. 35

I225 Pg. 31

I226 Pg. 30

I235 Pg. 34

I236 Pg. 34

I240 Pg. 32

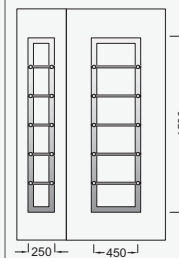
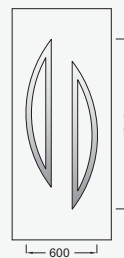
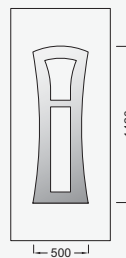
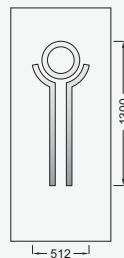
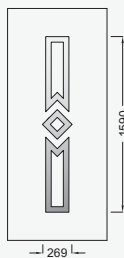

I320 Pg. 44

I325 Pg. 46

I330 Pg. 44

I335 Pg. 49

I340 Pg. 46

I383-I343 Pg. 36

I345 Pg. 47

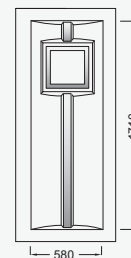
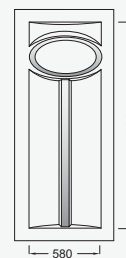
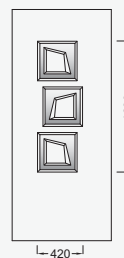
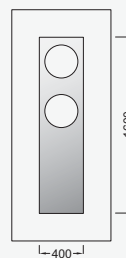
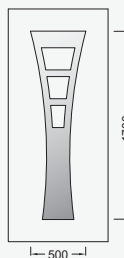
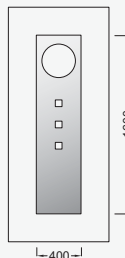

I380 Pg. 48

I385 Pg. 48

I392 Pg. 51

I396 Pg. 43

I400 Pg. 38

I405 Pg. 38

I410 Pg. 39

E2000 Series

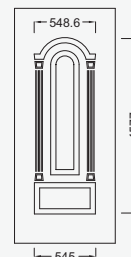
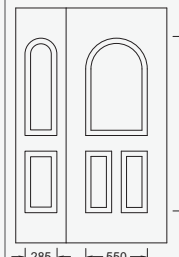
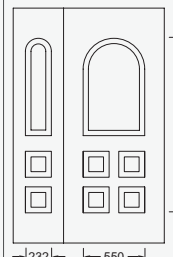
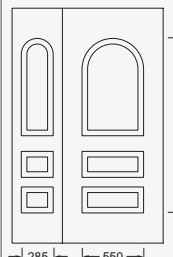
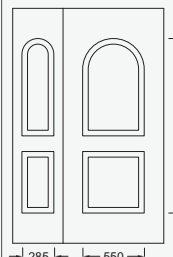
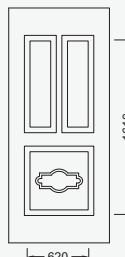
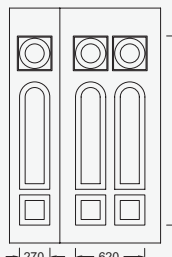

E210-E200 Pg. 106

E507 Pg. 54

E903-E510 Pg. 62-63

E504-E512 Pg. 62-64

E588-E513 Pg. 62, 64

E903-E517 Pg. 62, 65

E528 Pg. 56

CATALOGUE INDEX WITH DESIGN DIMENSIONS

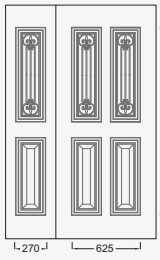

P106-P131 Pg.21

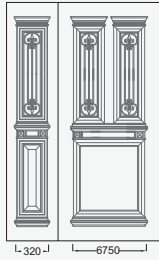

P105-P136 Pg.15

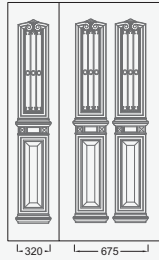

P115-P140 Pg.16

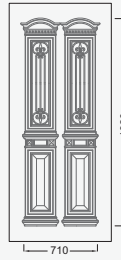

P164 Pg.19

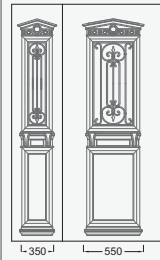

P138-P168 Pg.25-26

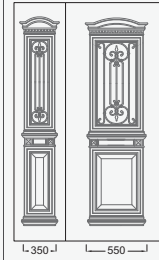

P177-P176 Pg.18, 20

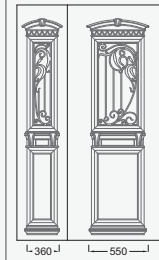

P129-P189 Pg.23-24



I245 Pg. 30

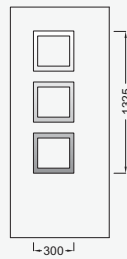

I250 Pg. 41

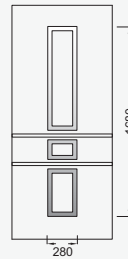

I260 Pg. 32

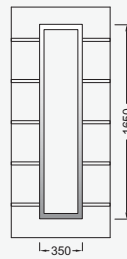

I270 Pg. 33

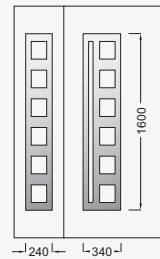

I313-I300 Pg. 45

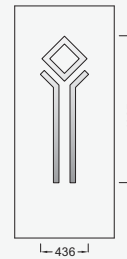

I310 Pg. 44

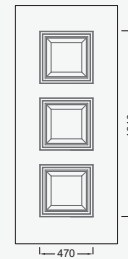

P190 Pg.22

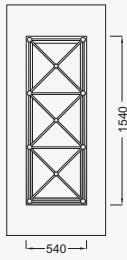

I347 Pg. 36

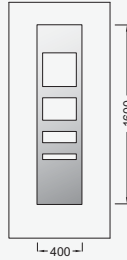

I350 Pg. 49

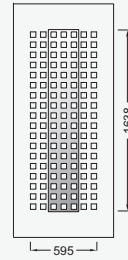

I357 Pg. 42

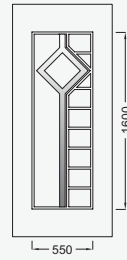

I362 Pg. 50

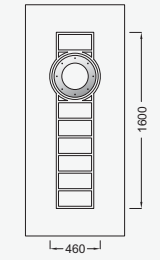

I372 Pg. 50

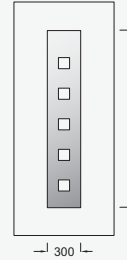

I375 Pg. 50

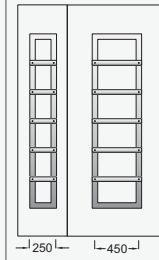

I388-I378 Pg. 37

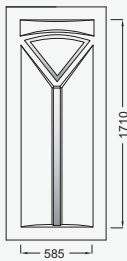

I415 Pg. 38

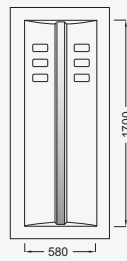

I417 Pg. 39

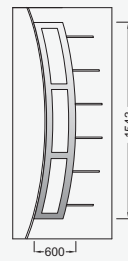

I420 Pg. 45

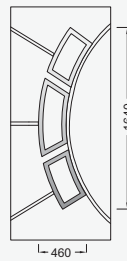

I425 Pg. 45

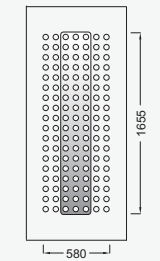

I429 Pg. 39

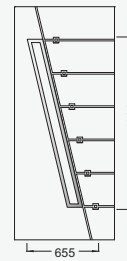

I450 Pg. 40

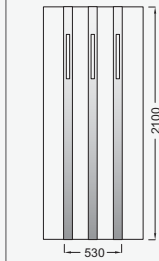

I455 Pg. 41

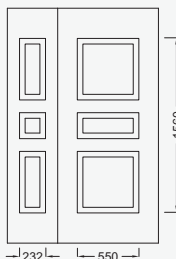

E810-E530 Pg. 60

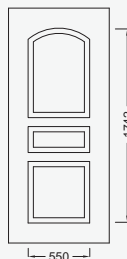

E532 Pg. 57



I460 Pg. 40

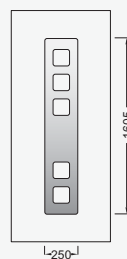

I465 Pg. 41

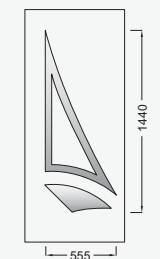

I480 Pg. 43

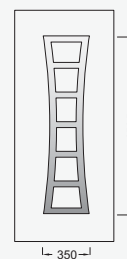



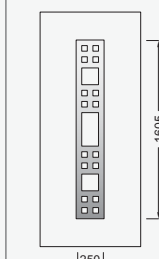





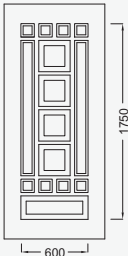
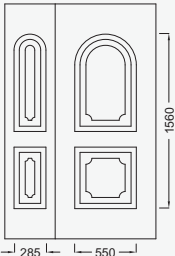

I490 Pg. 43

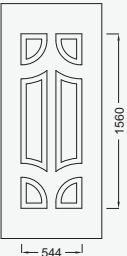
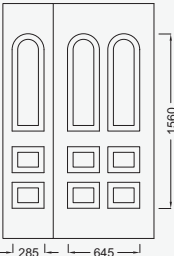
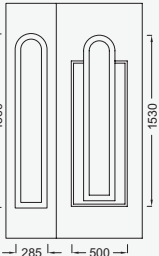

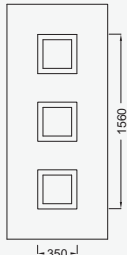
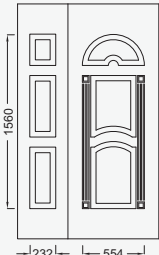
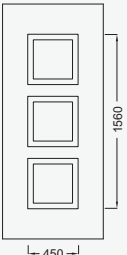
I495 Pg. 42

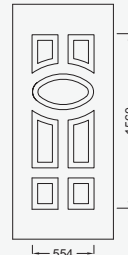
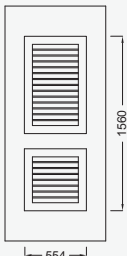
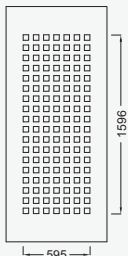
ΚΑΤΑΛΟΓΟΣ ΠΕΡΙΕΧΟΜΕΝΩΝ ΜΕ ΔΙΑΣΤΑΣΕΙΣ ΣΧΕΔΙΩΝ

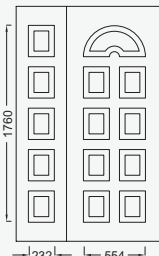
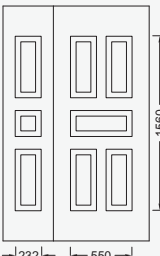
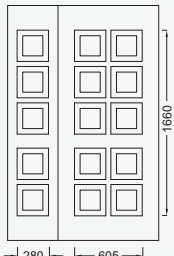
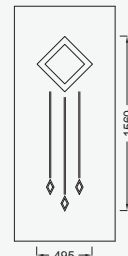
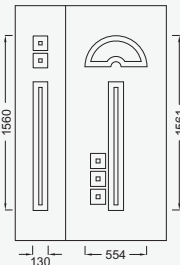
E2000 Series

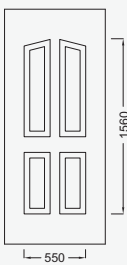
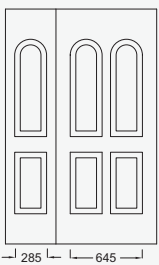
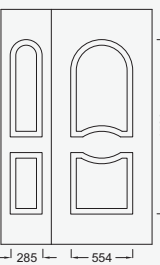
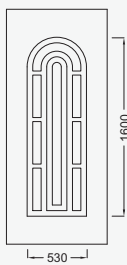
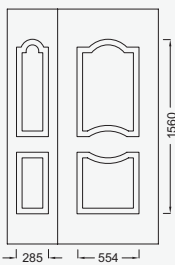
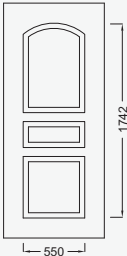
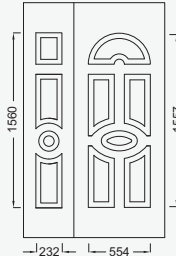
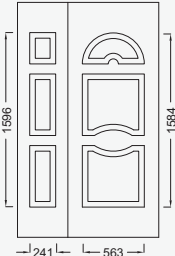
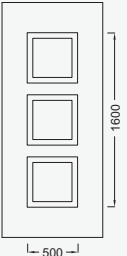
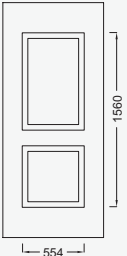
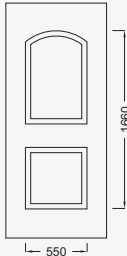
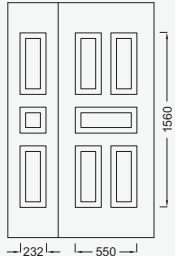
						
E534 Pg. 59	E536 Pg. 58	E554-E540 Pg. 62, 64	E545 Pg. 61	E547 Pg. 60	E504-E550 Pg. 66	E907-E552 Pg. 72
						
E710 Pg. 74	E714 Pg. 81	E720 Pg. 76	E986-E725 Pg. 75	E728 Pg. 76	E740 Pg. 79	E750 Pg. 83
						
E785 Pg. 80	E789 Pg. 81	E790 Pg. 82	E800-E803 Pg. 85	E810-E812 Pg. 86	E520-E820 Pg. 87	E845 Pg. 89
						
E562-E884 Pg. 70	E892-E895 Pg. 94	E897 Pg. 95	E903-E902 Pg. 96-97	E903-E910 Pg. 98	E922 Pg. 101	E933-E926 Pg. 99
						
P6120 Pg. 112	P6630-P6130 Pg. 114	P6750-P6140 Pg. 115	P6150 Pg. 116	P6160 Pg. 119	P6170 Pg. 120	P6680-P6180 Pg. 125

P6000 Series

CATALOGUE INDEX WITH DESIGN DIMENSIONS

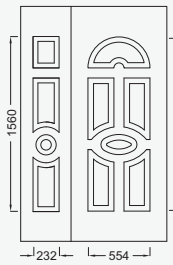

E856-E556 Pg. 67

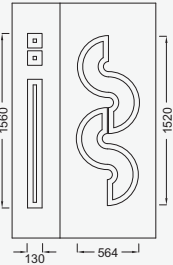

E562-E560 Pg. 70

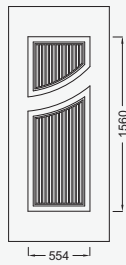

E564 Pg. 68

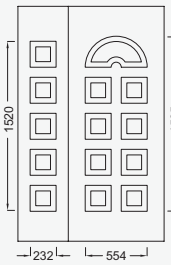

E572-E566 Pg. 69

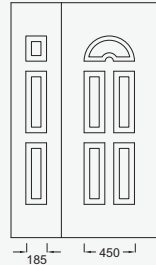

E590-E580 Pg. 71

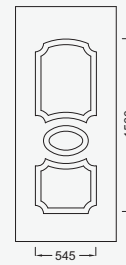

E586 Pg. 55

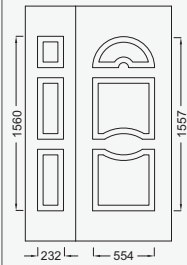

E986-E700 Pg. 73

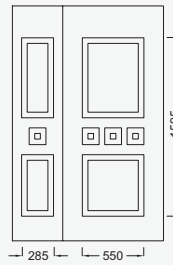

E762-E760 Pg. 78

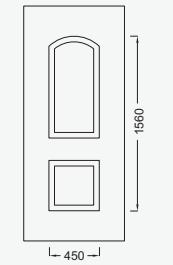

E770 Pg. 84

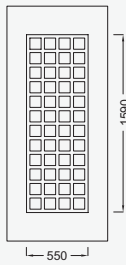

E780 Pg. 80

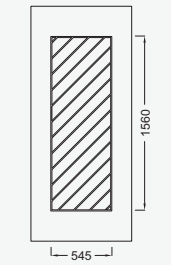

E781 Pg. 81

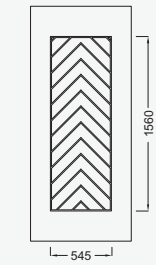

E782 Pg. 81

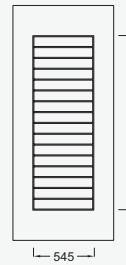

E783 Pg. 80

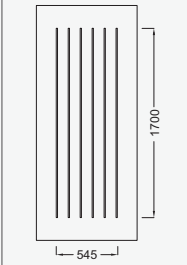

E784 Pg. 81

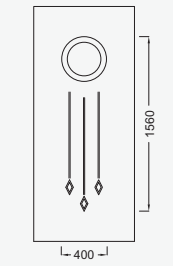

E847 Pg. 88

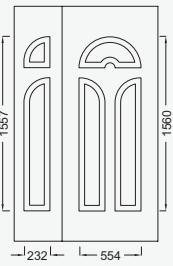

E854-E850 Pg. 90

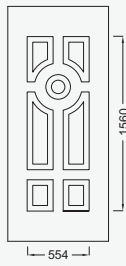

E860 Pg. 77

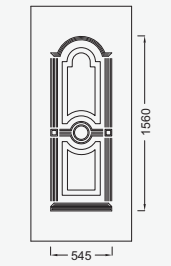

E870 Pg. 91

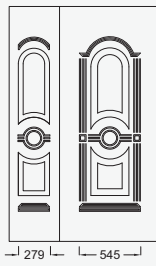

E865-E873 Pg. 92



E562-E875 Pg. 70

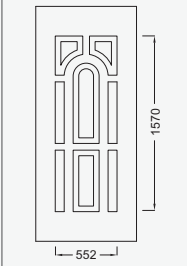

E880 Pg. 93

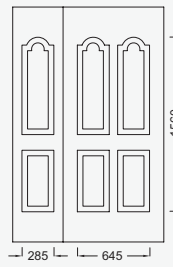

E933-E941 Pg. 100

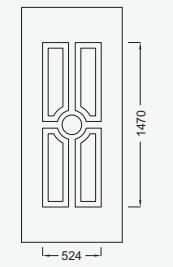

E951 Pg. 103



E957 Pg. 102

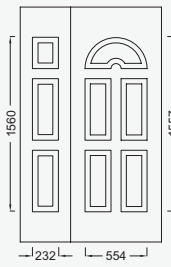

E986-E982 Pg. 104-105

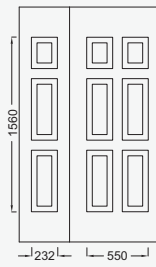

E986-E990 Pg. 107

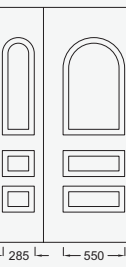

P6600-P6100 Pg. 110

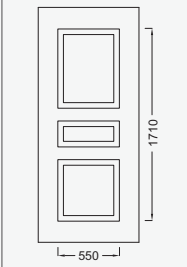

P6110 Pg. 111

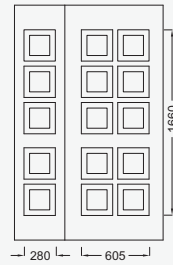

P6690-6190 Pg. 113

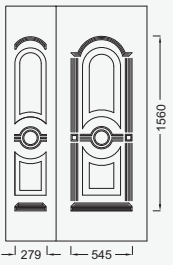

P6700-P6200 Pg. 117



P6710-P6210 Pg. 122

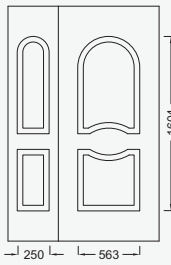

P6710-P6220 Pg. 121

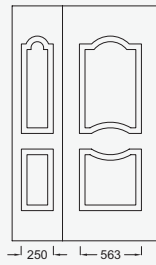

P6740-P6230 Pg. 118, 125



P6740-P6240 Pg. 123

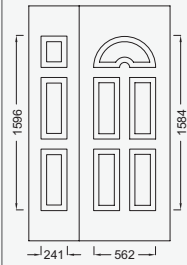

P6750-P6250 Pg. 124

P100 Series



P102



P102K



P103



P112



P113



P152



Παραδοσιακό | Traditional

- Νεοκλασικός χαρακτήρας
 - Φύλλο αλουμινίου 1,4mm
 - Τζάμια με ασφάλειες αλουμινίου
 - Επιλογή ανοιγόμενου παραθύρου
 - Εύκολη και άμεση αντικατάσταση τζαμιών με βίδες
 - Μεγάλη γκάμα σχεδίων και κατασκευών
 - Αναλλοίωτες και πιστοποιημένες βαφές και αποχρώσεις ξύλου
 - Δεν χρειάζεται συντήρηση
- Traditional and classic design
 - 1,4mm Aluminium sheet
 - Window with aluminium decorative safety
 - Opening window option
 - Quick and easy glass replacement with screws
 - Multiple design option
 - Certified powder coatings and wood imitation shades
 - Maintenance free

ΠΑΧΟΣ ΦΥΛΛΟΥ ΑΛΟΥΜΙΝΙΟΥ ALUMINIUM SHEET THICKNESS
1.4 mm
ΠΑΧΟΣ ΔΙΑΚΟΣΜΗΤΙΚΟΥ ΧΥΤΟΥ DECORATIVE CAST THICKNESS
4 mm
ΣΥΝΟΛΙΚΟ ΠΑΧΟΣ ΠΑΝΕΛ TOTAL PANEL THICKNESS
22-24 mm
ΑΠΟΚΟΛΛΗΣΗ ΚΟΡΝΙΖΑΣ ΑΠΟ ΕΠΙΦΑΝΕΙΑ ΤΟΥ ΠΑΝΕΛ FRAME DETACHMENT FROM PANEL SURFACE
50,02 Pa/mm²
ΑΠΟΚΟΛΛΗΣΗ ΦΥΛΛΟΥ ΑΛΟΥΜΙΝΙΟΥ ΑΠΟ ΜΟΝΩΤΙΚΟ SHEET DETACHMENT FROM INSULATION MATERIAL
0,488 N/mm²
ΣΥΝΤΕΛΕΣΤΗΣ ΘΕΡΜΙΚΗΣ ΑΝΤΙΣΤΑΣΗΣ THERMAL RESISTANCE COEFFICIENT
$RD = m^2 * K/W = 0,55$
ΣΥΝΤΕΛΕΣΤΗΣ ΘΕΡΜΙΚΗΣ ΑΓΩΓΙΜΟΤΗΤΑΣ THERMAL CONDUCTIVITY COEFFICIENT
$\lambda d = W/M * K = 0,035$



P142



P143



P162



P132



P133



P190

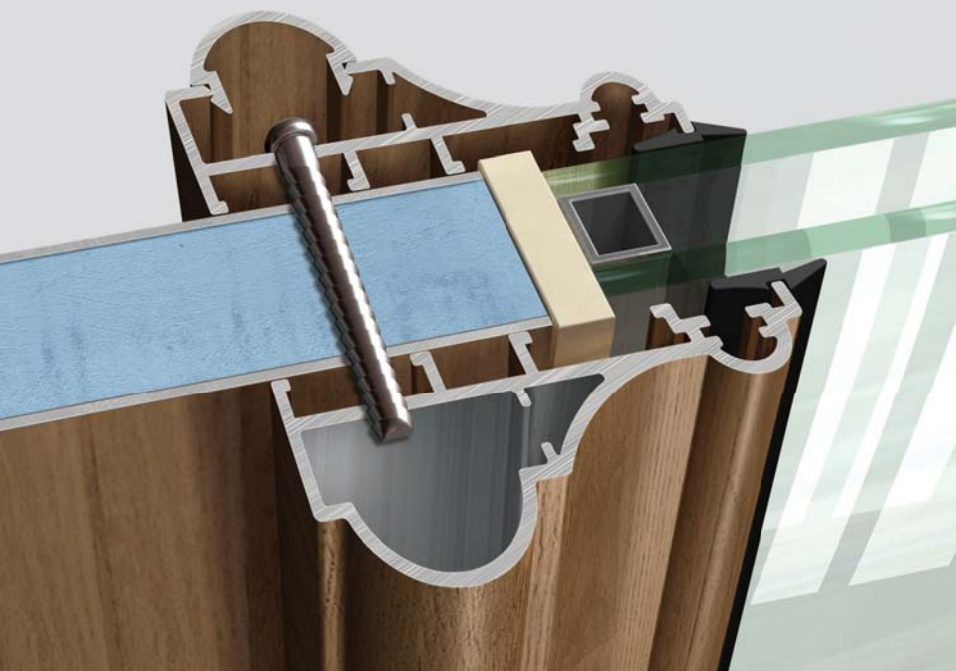

P100 Series

Classic



P106

P101

Επιλογή διακοσμητικής ασφάλειας
εσωτερικά του κρυστάλλου.
Decorative safety option



P121



P181

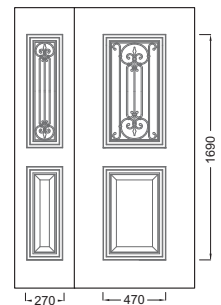



P159 Vitro-B K (Brown)

P158 Vitro-B K (Brown)

Επιλογή Vitro
Vitro option

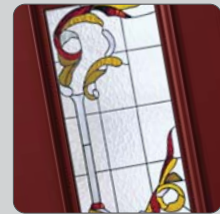

Vitro-A K (Brown)

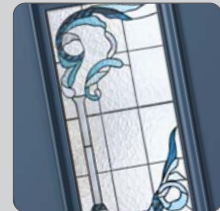

Vitro-A M (Blue)



Vitro-A Π (Green)



Vitro-B Λ (White)



Vitro-B M (Blue)

P100 Series

Classic



P105

P100

Επιλογή διακοσμητικής ασφάλειας
εσωτερικά του κρυστάλλου.
Decorative safety option



P125



P120



P175



P170



P183



P155 Vitro-A K (Brown)

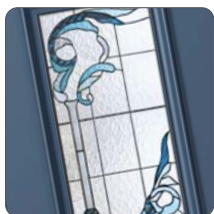

Vitro-A M (Blue)



Vitro-A Π (Green)



P124

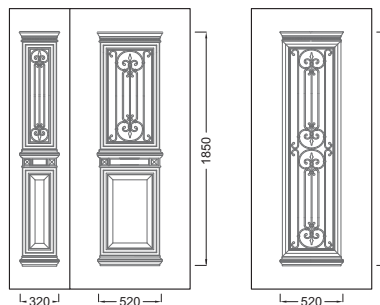

P100 Series

Classic



P175

P171

Επιλογή διακοσμητικής ασφάλειας
εσωτερικά του κρυστάλλου.
Decorative safety option



P130



P150

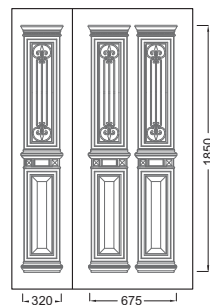



P105

P136

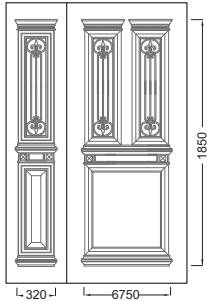

P100 Series

Classic



P140



P116

P111



P115

P110

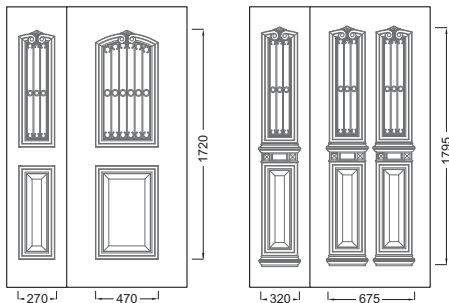



P115 Vitro-B M (Blue)

P110 Vitro-B M (Blue)

Επιλογή Vitro
Vitro option



Vitro-B A (White)



Vitro-B K (Brown)

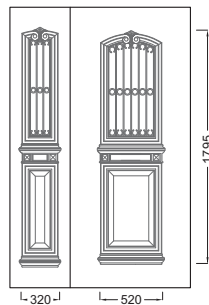

P100 Series

Classic



P185

P180

Επιλογή διακοσμητικής ασφάλειας
εσωτερικά του κρυστάλλου.
Decorative safety option



P177

P176



P179

P178



P182



P160



P162



P164



P163

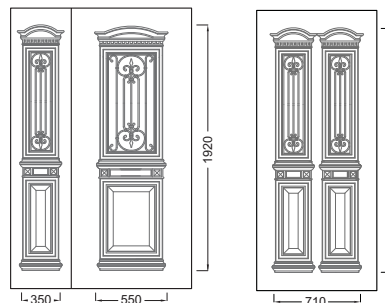

P100 Series

Classic



P153 Vitro-A M (Blue)

P154 Vitro-A M (Blue)



P152



P154 Vitro-A П (Green)

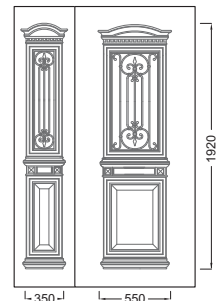



P151



P161



P131



P156 Vitro-A K (Brown)

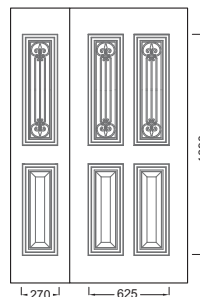

P100 Series

Classic

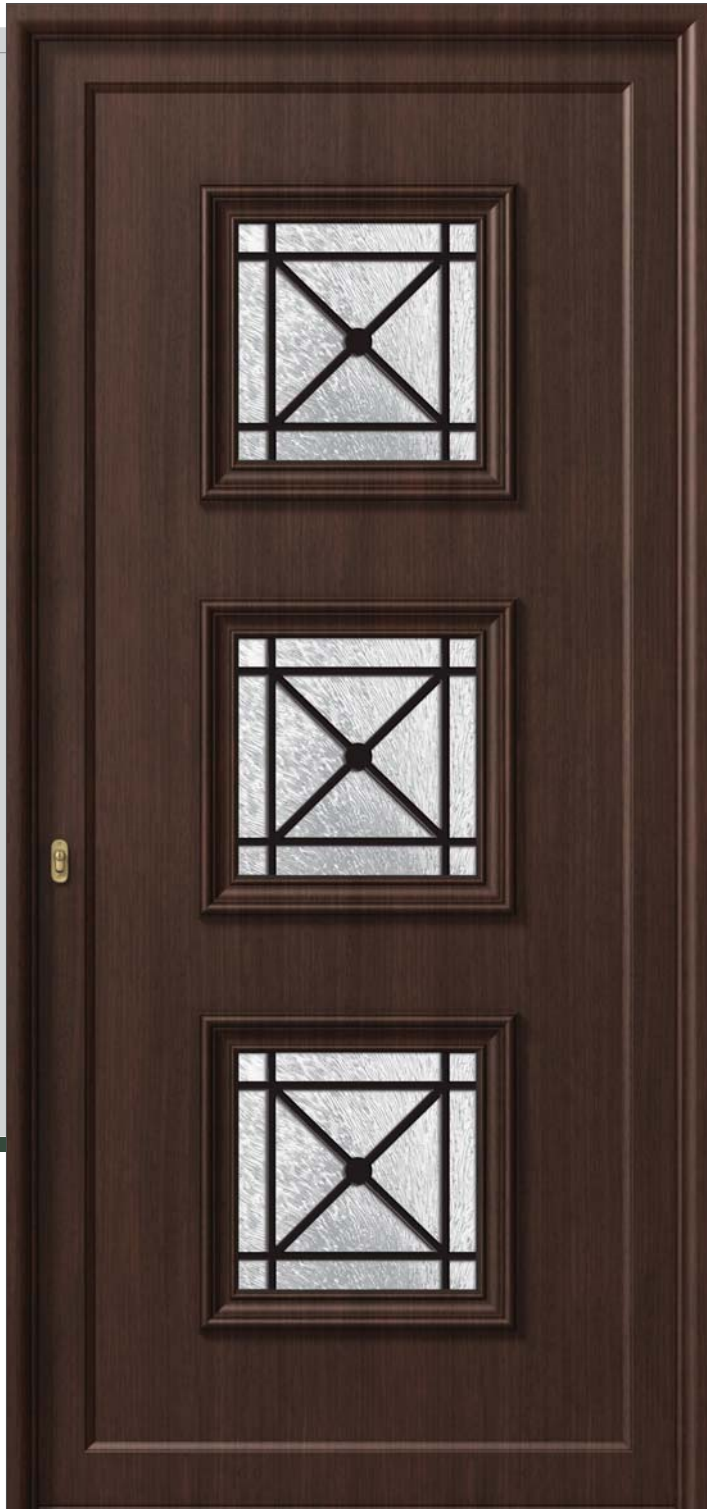

P193



P191

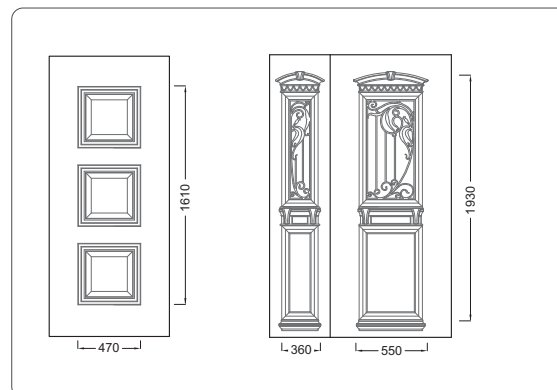



P129

P189

Επιλογή διακοσμητικής ασφάλειας
εσωτερικά του κρυστάλλου.
Decorative safety option



P109



P149



P128



P148

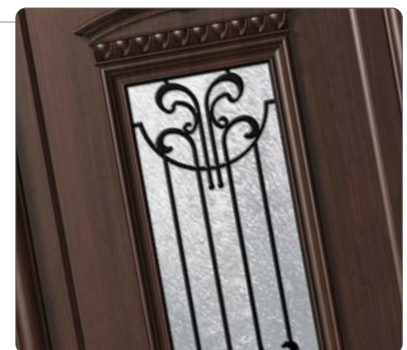

P198

P100 Series

Classic



P129 Vitro-A П (Green)

P189 Vitro-A П (Green)



Vitro-A M (Blue)



Vitro-A K (Brown)

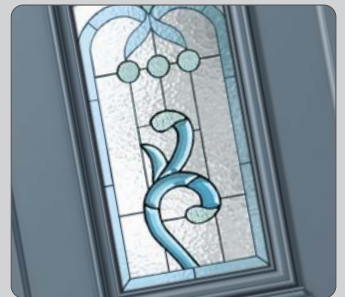

Vitro-B M (Blue)

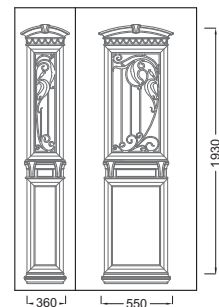



P138 Vitro-B K (Brown)

P168 Vitro-B K (Brown)

Επιλογή Vitro
Vitro option

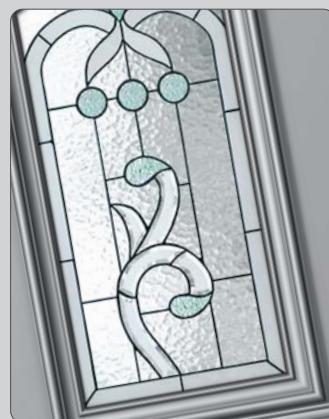

Vitro-B Λ (White)



Vitro-A K (Brown)

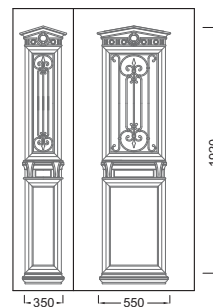

P100 Series

Classic



P138

P168

Επιλογή διακοσμητικής ασφάλειας
εσωτερικά του κρυστάλλου.
Decorative safety option



P194



P174



P114

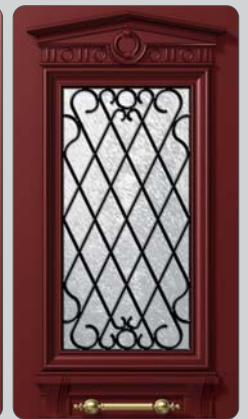

P169

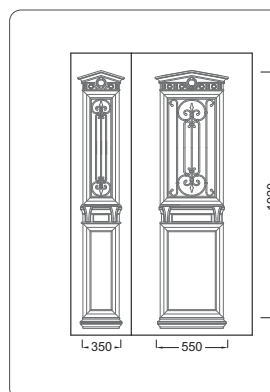

P199

ΕΙΔΙΚΟ ΣΧΕΔΙΟ

Για πόρτες με ύψος κάτω από 2m.

SPECIAL DESIGN

Ideal for doors less than 2m height,

K



P107 K

P102 K



P175 K

P170 K



P105 K

P100 K

I300 Series



New

1460



New

1455



New

1245



Μοντέρνο | Modern

- Έντονα μοντέρνος χαρακτήρας
- Τζάμια διπλής υάλωσης
- Επιλογές ειδικά κατεργασμένων τζαμιών
Fused υψηλής αισθητικής και αυξημένης αντοχής
- Αυξημένη θερμομόνωση & ηχομόνωση
- Αναλλοίωτες και πιστοποιημένες βαφές και αποχρώσεις ξύλου

- Innovative design
- Double glazing
- Fused glazing with Inox for extra resistance and high aesthetics
- Exceptional heat and sound insulation coefficient
- Certified powder coatings and wood imitation shades

ΠΑΧΟΣ ΦΥΛΛΟΥ ΑΛΟΥΜΙΝΙΟΥ ALUMINIUM SHEET THICKNESS
1,4 mm
ΣΥΝΟΛΙΚΟ ΠΑΧΟΣ ΠΑΝΕΛ TOTAL PANEL THICKNESS
24 mm
ΑΠΟΚΟΛΛΗΣΗ ΚΟΡΝΙΖΑΣ ΑΠΟ ΕΠΙΦΑΝΕΙΑ ΤΟΥ ΠΑΝΕΛ FRAME DETACHMENT FROM PANEL SURFACE
50,02 Pa/mm²
ΑΠΟΚΟΛΛΗΣΗ ΦΥΛΛΟΥ ΑΛΟΥΜΙΝΙΟΥ ΑΠΟ ΜΟΝΩΤΙΚΟ SHEET DETACHMENT FROM INSULATION MATERIAL
0,488 N/mm²
ΣΥΝΤΕΛΕΣΤΗΣ ΘΕΡΜΙΚΗΣ ΑΝΤΙΣΤΑΣΗΣ THERMAL RESISTANCE COEFFICIENT
RD = m² * K/W = 0,55
ΣΥΝΤΕΛΕΣΤΗΣ ΘΕΡΜΙΚΗΣ ΑΓΩΓΙΜΟΤΗΤΑΣ THERMAL CONDUCTIVITY COEFFICIENT
λd = W/M * K = 0,035



I300 Series

Πάχος φύλλου αλουμινίου 2mm
Aluminium sheet thickness 2mm



I226



I245

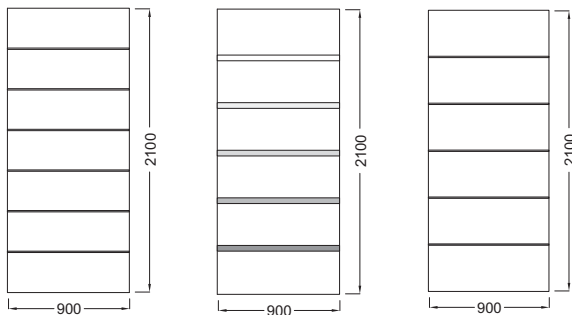

New

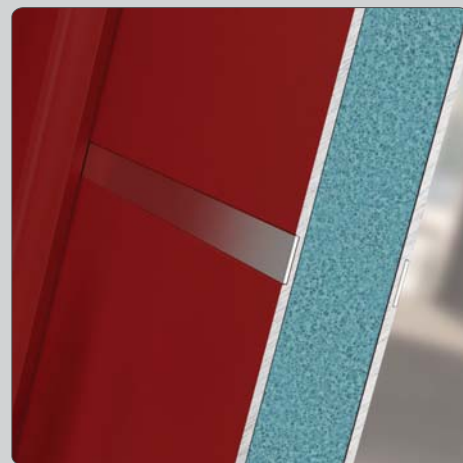

- Πάχος φύλλου αλουμινίου 2mm
- Χάραξη πάνελ 1mm σε μορφή «Π»
- Λωρίδες Inox 10mm & 20mm
- Σχέδια πάνελ με 5 & 6 διακοσμητικές λωρίδες Inox
- Aluminium sheet thickness 2mm
- 1mm milling in «Π» shape
- 10mm & 20mm Inox lines
- Panel design with 5 & 6 Inox lines

I300 Series

Πάχος φύλλου αλουμινίου 2mm
Aluminium sheet thickness 2mm

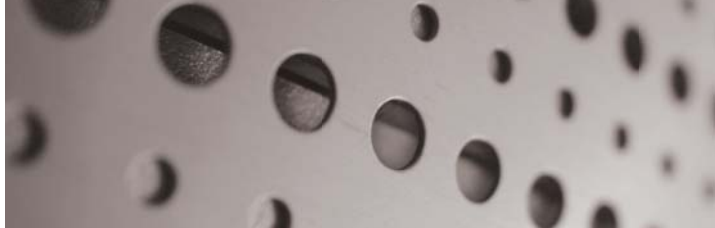

I243 Deco 4



I263 Deco 3

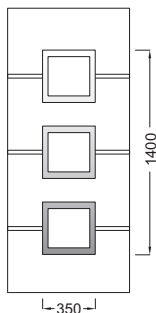

I263 Deco 4



I263 Deco 1

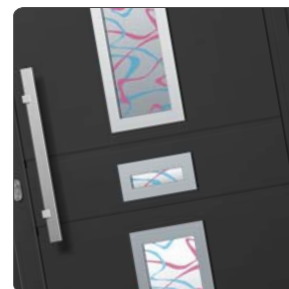

I263 Deco 8



I221 Super Silver



I271 Super Silver

Διακοσμητικό καθρεπτιζον τζάμι Super Silver. Καθρέπτης εξωτερικά, φθοριωμένο τζάμι εσωτερικά.

Decorative mirror glass Super Silver. Mirror effect outside, fluoridated glass inside.

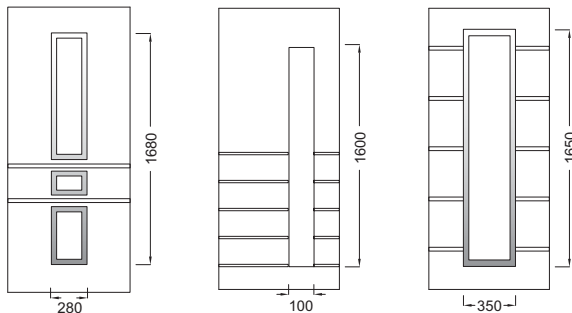

I300 Series

Πάχος φύλλου αλουμινίου 2mm
Aluminium sheet thickness 2mm



I236 (6 Διακοσμητικές γραμμές / 6 Decorative lines)



I235 (5 Διακοσμητικές γραμμές / 5 Decorative lines)

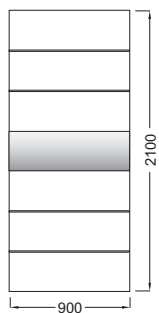
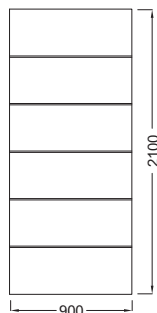
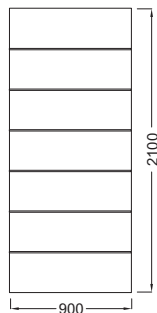

New



- Πάχος φύλλου αλουμινίου 2mm
- Χάραξη πάνελ 0.8mm σε μορφή «V»
- Σχέδια πάνελ με 5 & 6 διακοσμητικές γραμμές
- Aluminium sheet thickness 2mm
- 0.8mm milling in «V» shape
- Panel design with 5 & 6 milled lines

I300 Series

Πάχος φύλλου αλουμινίου 2mm
Aluminium sheet thickness 2mm



I348 Αμμοβολή/Sand Blasted Glass



I384 Super Silver

I344 Super Silver

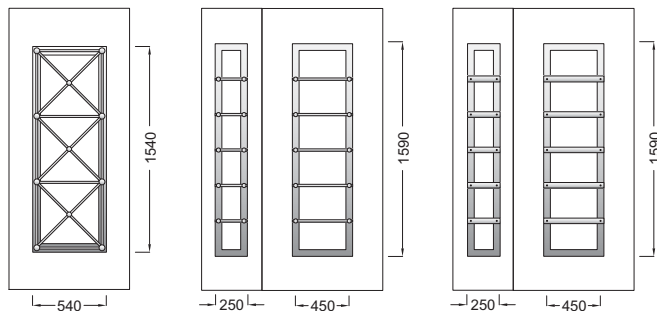



New



Κουρμπριστή ασφάλεια πάχους 3mm & πλάτους 50mm.

Curved safety with 3mm thickness & 50mm width.

I389 Αμμοβολή/Sand Blasted Glass

I379 Αμμοβολή/Sand Blasted Glass

I300 Series

Inox



New



I406 FU-1

New



I416 FU-1

New



I403 FU-1



I417



I411 FU-1



I429

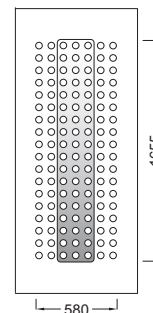
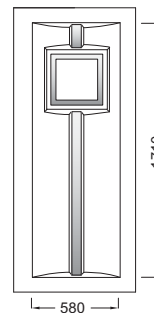
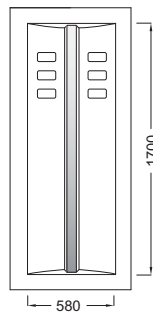
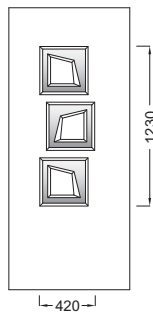
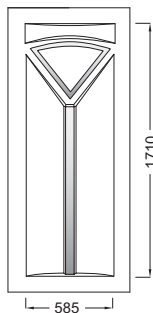
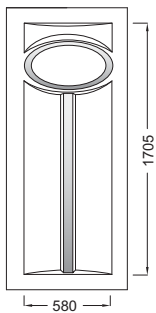

I300 Series

Inox



New

I460



New

I451 Super Silver

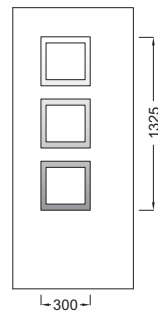
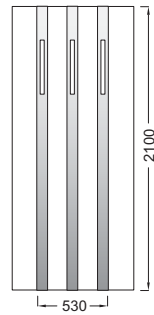
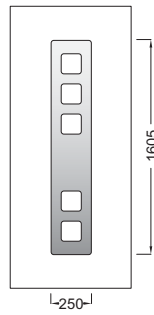
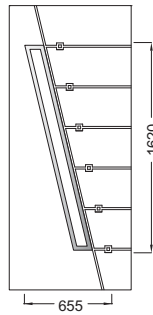
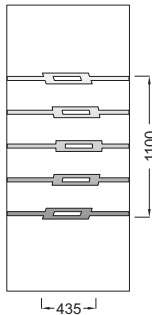



New

1466



New

1253 Deco 3



New

1455

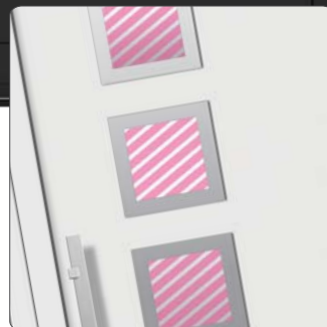

1253 Deco 6

I300 Series

Inox

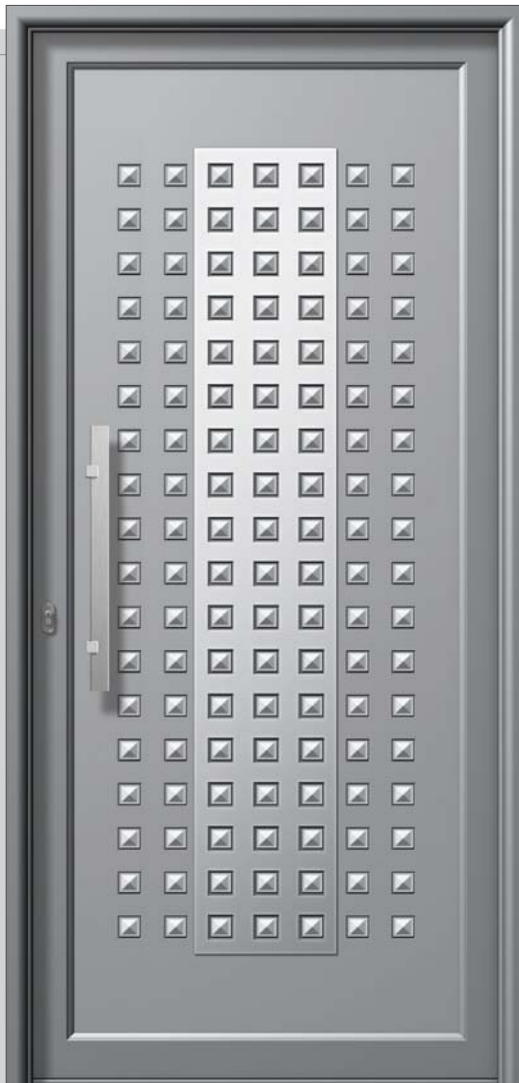
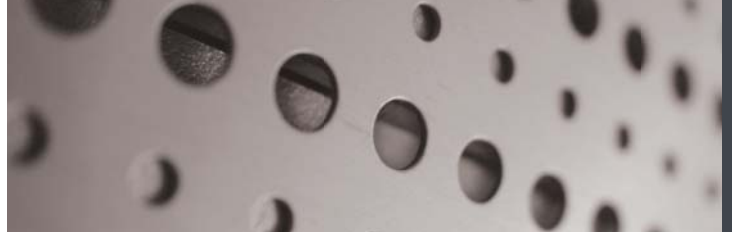

I357



I496 Αμμοβολή/Sand Blasted Glass

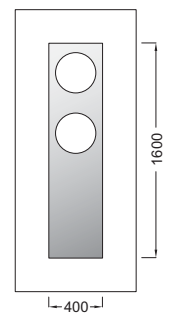
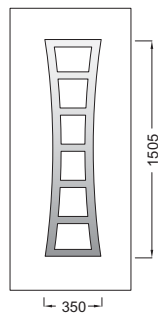
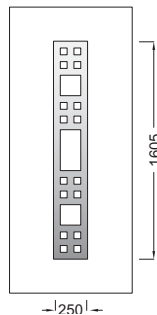
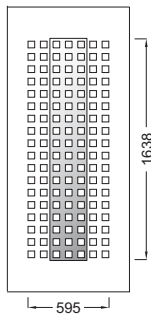



I491 BR-2



I481



I398 FU-1

I300 Series

Inox



I311M CA



I323 FU-1



I331 FU-1

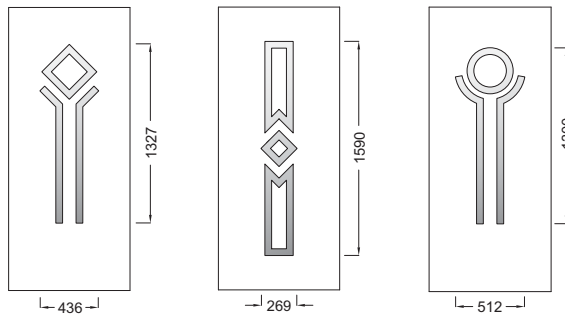



I315 FU-1

I303 FU-1



New

I428 Αμμοβολή/Sand Blasted Glass



New

I423 Super Silver

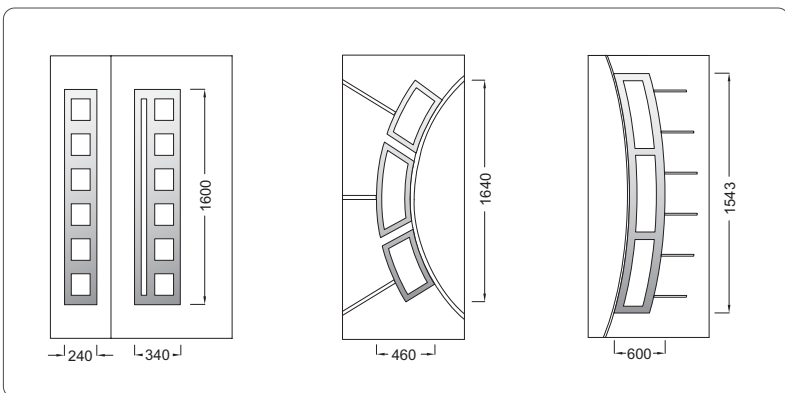

I300 Series

Inox



I342 FU-2



I327 VI-1

Διακοσμητικά τζάμια & Vitro
Decorative glass & Vitro



I342 FU-1



I327 CA

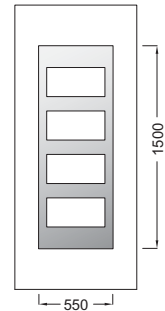
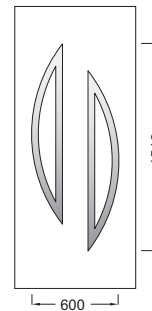

Διακοσμητικά τζάμια
Decorative glass



I346 BR-2



I346 BR-1



I346 FU-3

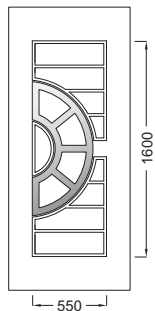

I300 Series

Inox

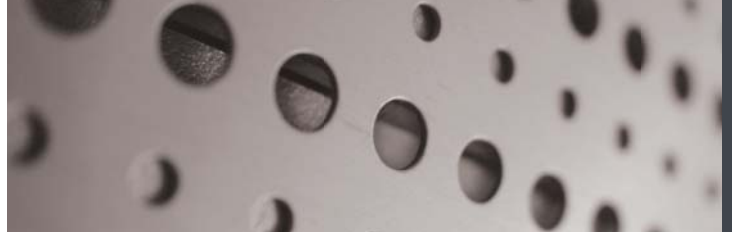

I382M FU-1



I387 Super Silver

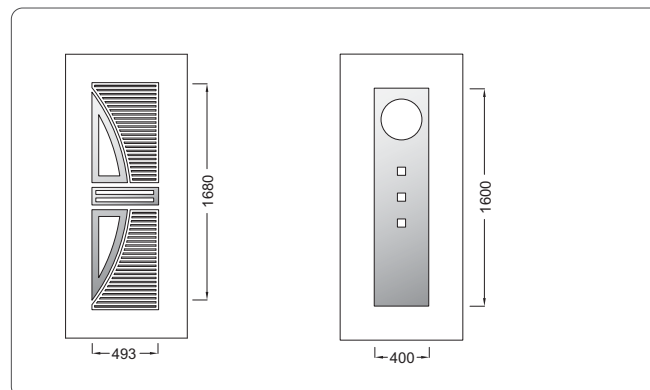



I354 FU-1



I337M FU-1

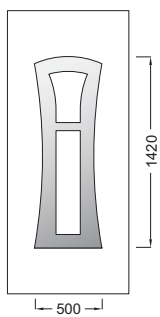
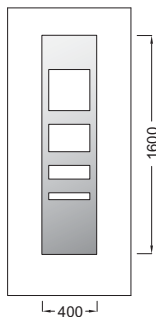

I300 Series

Inox



I363 Super Silver



I373M FU-1



I376 FU-1

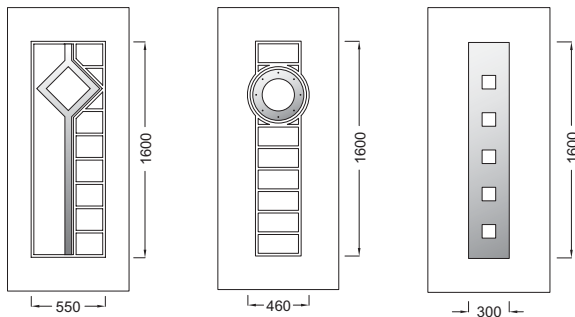

Διακοσμητικά τζάμια
Decorative glass



I395M FU-1



I395M FU-2



I395M FU-3

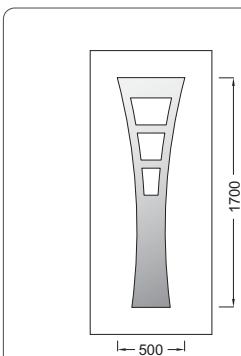

E2000 Series



E532



E982



Ευέλικτο | Flexible

- Μοντέρνος χαρακτήρας
- Ευέλικτο design
- Μεγάλη γκάμα κρυστάλλων
- Τζάμια διπλής υάλωσης
- Επιλογές ειδικά κατεργασμένων τζαμιών
- Fused υψηλής αισθητικής και αυξημένης αντοχής*
- Επιλογές ενσωματωμένων ασφαλειών για αντικλεπτική προστασία
- Τεράστια ποικιλία σχεδίων και κατασκευών
- Αναλλοίωτες και πιστοποιημένες βαφές και αποχρώσεις ξύλου
- Δεν χρειάζεται συντήρηση

- Modern design
- Wide selection of glasses
- Double glazing
- Fused glazing with Inox for extra resistance and high aesthetics*
- Cast aluminium security for extra protection
- Multiple design option
- Certified powder coatings and wood imitation shades
- Maintenance free

ΠΑΧΟΣ ΦΥΛΛΟΥ ΑΛΟΥΜΙΝΙΟΥ ALUMINIUM SHEET THICKNESS
1 mm
ΣΥΝΟΛΙΚΟ ΠΑΧΟΣ ΠΑΝΕΛ TOTAL PANEL THICKNESS
23 mm
ΑΠΟΚΟΛΛΗΣΗ ΚΟΡΝΙΖΑΣ ΑΠΟ ΕΠΙΦΑΝΕΙΑ ΤΟΥ ΠΑΝΕΛ FRAME DETACHMENT FROM PANEL SURFACE
50,02 Pa/mm²
ΑΠΟΚΟΛΛΗΣΗ ΦΥΛΛΟΥ ΑΛΟΥΜΙΝΙΟΥ ΑΠΟ ΜΟΝΩΤΙΚΟ SHEET DETACHMENT FROM INSULATION MATERIAL
0,488 N/mm²
ΣΥΝΤΕΛΕΣΤΗΣ ΘΕΡΜΙΚΗΣ ΑΝΤΙΣΤΑΣΗΣ THERMAL RESISTANCE COEFFICIENT
RD = m² * K/W = 0,55
ΣΥΝΤΕΛΕΣΤΗΣ ΘΕΡΜΙΚΗΣ ΑΓΩΓΙΜΟΤΗΤΑΣ THERMAL CONDUCTIVITY COEFFICIENT
λd = W/M * K = 0,035

*Το κάθε τζάμι FUSED είναι διαφορετικό λόγω του ότι είναι χειροποίητο με ειδική κατεργασία ενώ παράλληλα το πραγματικό προϊόν μπορεί να διαφέρει μερικώς από την απεικόνιση του σχεδίου στον κατάλογο.

*Each FUSED glass is different due to its handmade special procedure so the original product can be partially varied from the catalogue's photo appearance.

E2000 Series



E507



E508 Καίτη/Transom



E508 Ασφάλεια 1/Safety 1



E586



E587 Καίτη/Transom Inox

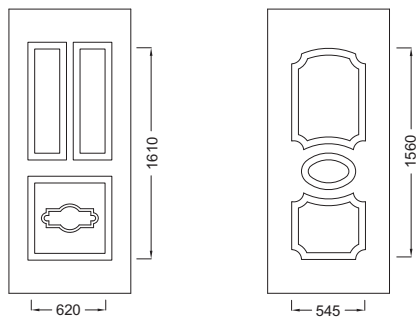

E2000 Series



E529 Deco 1



E528



E529 Kağıt/Transom



E532



E533 Καίτη/Transom



E533 Vitro 2



E533 Ασφάλεια 4/Safety 4

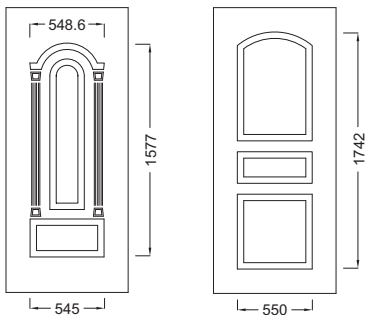

E2000 Series



E537 Ασφάλεια 1/Safety 1



E537 Fused 1



E537 Fused 3



E536

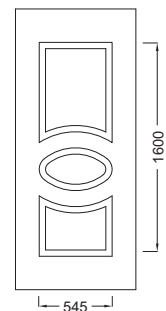
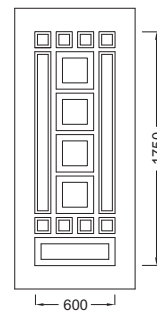



E535 Ασφάλεια 1/Safety 1



E534



E535 Καίτη/Transom



E535 Fused 1

E2000 Series



E810

E530



E531 Καϊτι/Transom Inox



E531 Ασφάλεια 1/Safety 1



E548 Καϊτι/Transom



E547



E548

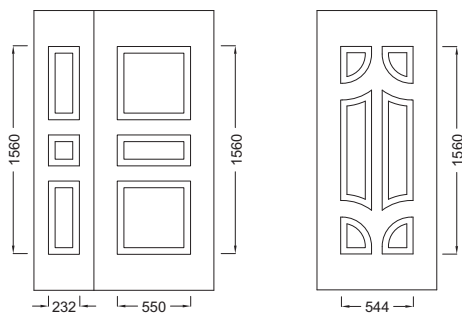



E545



E546 Fused 1



E546 Καίτη/Transom



E546 Fused 2

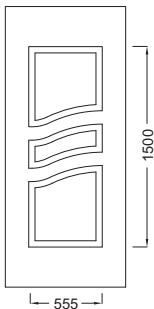

E2000 Series

Κλασικό Design σε 5 παραλλαγές
5 Classic Designs



E903



E510



E504



E512



E588



E513



E554



E540



E903



E517



E905 Ασφάλεια 2/Safety 2

E514 Ασφάλεια 3/Safety 3



E506 Ασφάλεια 1/Safety 1

E515 Ασφάλεια 1/Safety 1

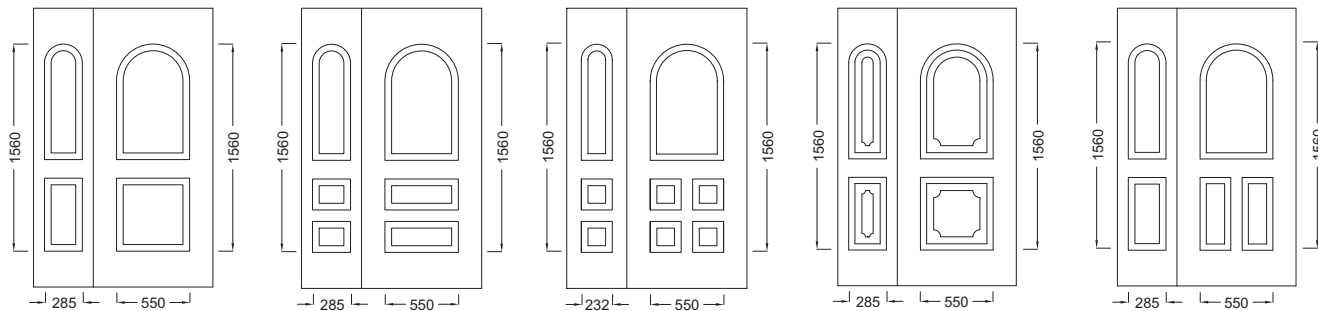

E2000 Series

Κλασικό Design σε 5 παραλλαγές
5 Classic Designs



E515 Ασφάλεια 3/Safety 3



E541 Ασφάλεια 1/Safety 1



E516 Ασφάλεια 2/Safety 2



Καίτη/Transom

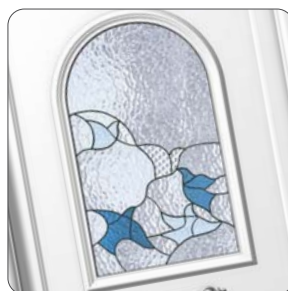

Vitro 2



E905 Καίτι Ρόμβος/Transom Rhombus

E518 Καίτι Ρόμβος/Transom Rhombus



E2000 Series



E506 Καράβολο/Karavolo

E551 Καράβολο/Karavolo



E504

E550

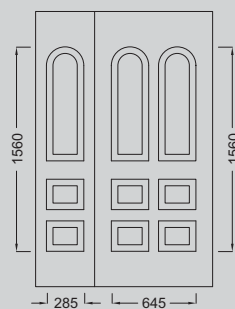

Αμμοβολή σχέδιο
Sandblasting with design



Καίτι/Transom



Deco 1



Vitro 1



E856

E556

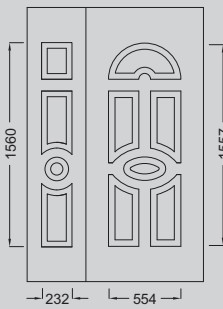

E858

E558 Καίτη/Transom



E557 Καίτη/Transom Inox

E2000 Series



E565 Ασφάλεια 1/Safety 1



E564



Fused 1

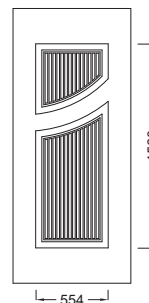



E575 Fused 7

E569 Fused 7



E572

E566



Fused 6



Ασφάλεια 5/Safety 5

New

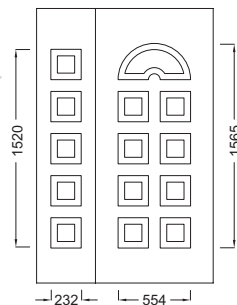

E2000 Series



E562

E875



E563

E878



E562

E884



E563

E886



E563

E561

ΕΙΔΙΚΟ ΣΧΕΔΙΟ 45cm ΠΛΑΤΟΣ
SPECIAL DESIGN 45cm WIDTH



E590

E580



E592 Καίτη/Transom

E583 Καίτη/Transom

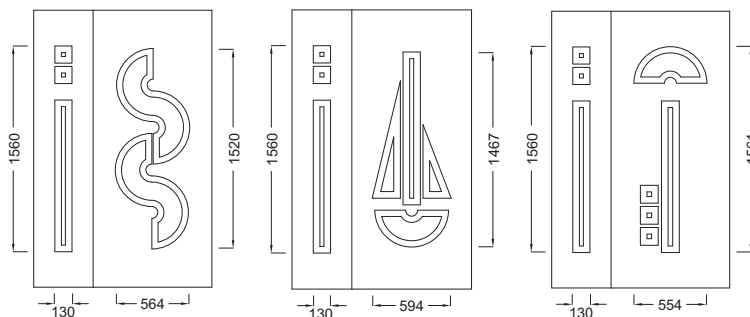

Ειδικό σχέδιο / Special design

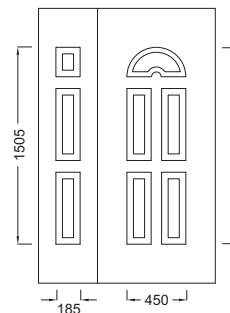

E2000 Series



E908 Deco 2

E553 Deco 2



E552



Deco 1



Ασφάλεια 1/Safety 1

New

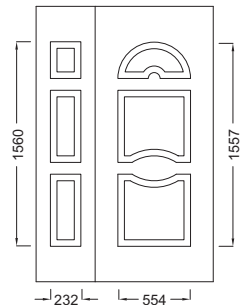
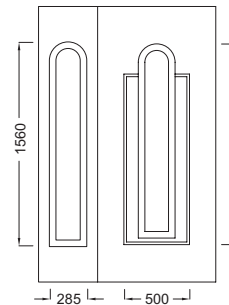



E988 Fused 4

E702 Fused 4



E700



E702 Ασφάλεια 5/Safety 5



E701 Fused 4



E702 Καίτι/Transom

E2000 Series



E711 Καίτη/Transom Inox



E711 Ασφάλεια 2/Safety 2



E710



Καίτη/Transom



Fused 4

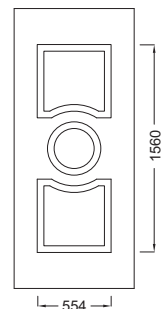



E727 Fused 9

New



E727 Ασφάλεια 6/Safety 6

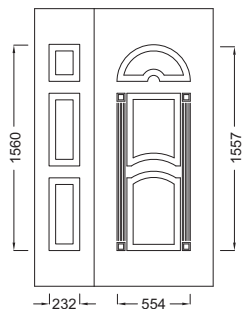

E725

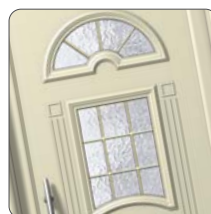

Καίτη/Transom

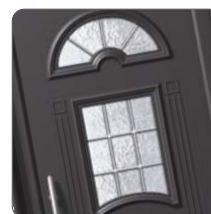

Καίτη/Transom Inox

E2000 Series



E731 Ασφάλεια 1/Safety 1



E729 Ασφάλεια 1/Safety 1



E720



E728

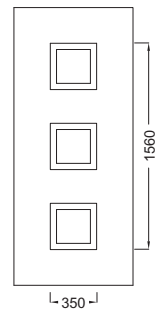
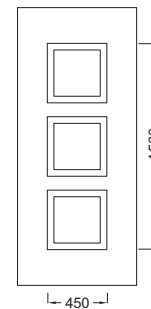



E860

New



E864 Ασφάλεια 1/Safety 1

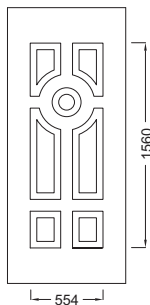

E864



E864 Καίτη/Transom Inox

E2000 Series



E761 Ασφάλεια 5/Safety 5



E761 Καίτη/Transom



E760

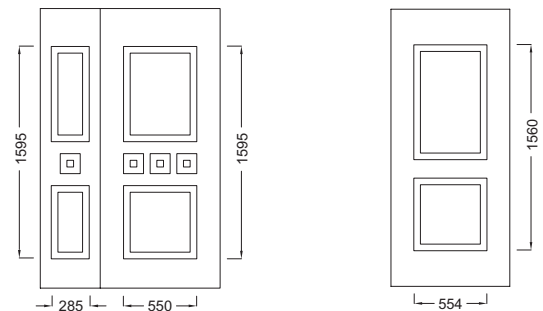



E740



E741 Ασφάλεια 4/Safety 4



E741 Ασφάλεια 1/Safety 1



Καίτη/Transom



Fused 2



Ασφάλεια 3/Safety 3

E2000 Series



E783



E780



E785

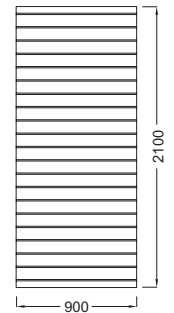
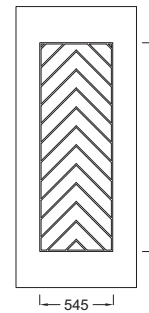
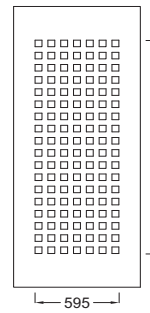
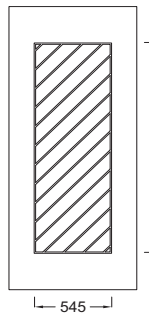
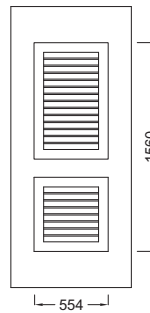
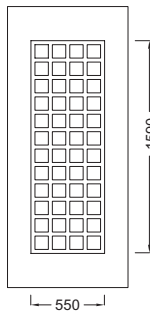
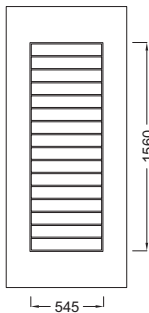



E781



E789



E784



E782



E714

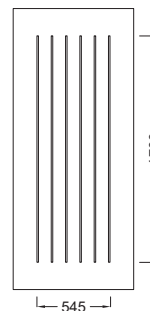

Όλα τα καίτια διατίθενται σε Λευκό, Χρυσό και Inox. All decorative transoms are available in White, Gold and Inox.

E2000 Series

E2000 Series



E792 Ασφάλεια 4/Safety 4



E791 Καίτη/Transom



Καίτη/Transom Inox



E790

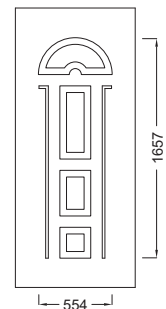



E750



Ασφάλεια 1/Safety 1



E751 Deco 1

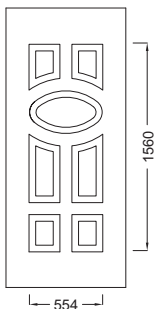

E2000 Series



E771 Καίτι/Transom Inox



E770



E771 Ασφάλεια 3
Safety 3



E771 Ασφάλεια 1/Safety 1

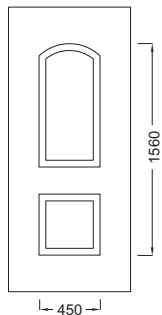



E800



E807 Fused 4

E803 E801 Fused 4

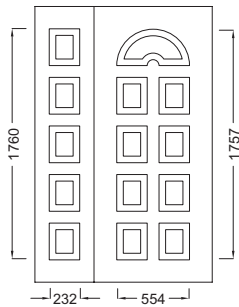

Καίτη/Transom



Ασφάλεια 4/Safety 4

E2000 Series

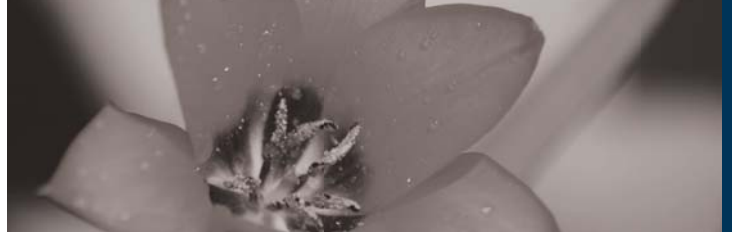

E812



E811 Kaïtu/Transom Inox

E814 Kaïtu/Transom Inox

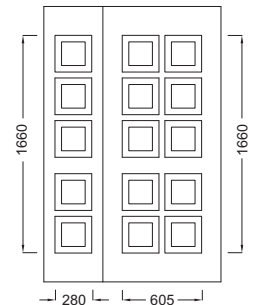
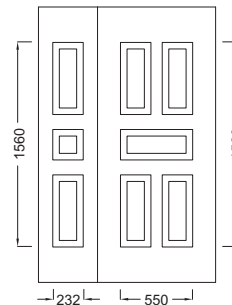



E520



E820 E523 Ασφάλεια 1/Safety 1

E826 Ασφάλεια 1/Safety 1



Καίτη/Transom



Fused 3

E2000 Series



E848 Ασφάλεια 1/Safety 1



E848 Καίτη/Transom Inox



E847



Fused 1

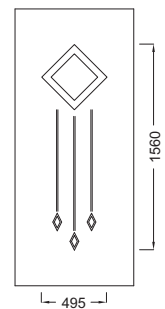
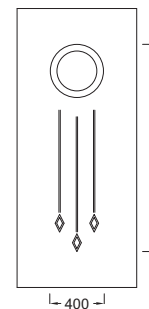



New

E846 Ασφάλεια 1/Safety 1



E846 Fused 1

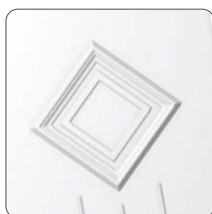

E845



Καίτη/Transom

E2000 Series



E851 Ασφάλεια 4/Safety 4

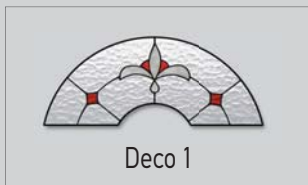

Deco 1



E855L Καίτη/Transom

E851 Καίτη/Transom

E855R Καίτη/Transom



E850



E853 Καίτη/Transom

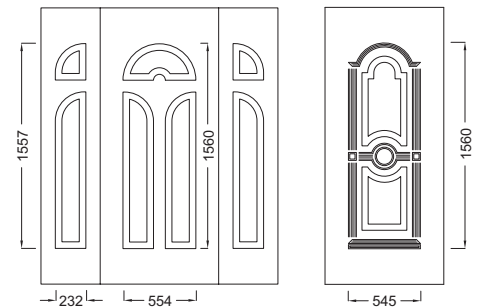



E870



E871 Deco 1



E871 Ασφάλεια 3/Safety 3



Καίτι/Transom



Ασφάλεια 1/Safety 1



Ασφάλεια 2/Safety 2

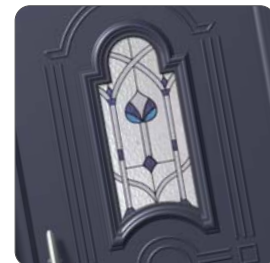

Deco 2

E2000 Series



E865



E873

E866

E874 Καίτι/Transom



Vitro 1

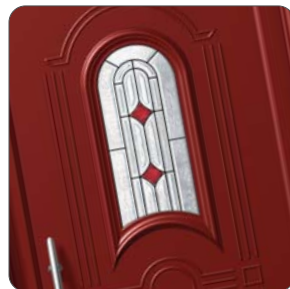

Deco 1



Ασφάλεια 2/Safety 2



Ασφάλεια 3/Safety 3



E881 Deco 2



E880



Καίτι/Transom



E881 Ασφάλεια 1/Safety 1

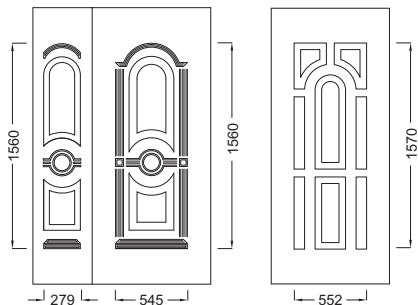

E2000 Series



E899 Fused 1



E893 Kaıtı/Transom Inox

E896 Kaıtı/Transom Inox



E895



Kaıtı/Transom



E897



E898 Καίτη/Transom

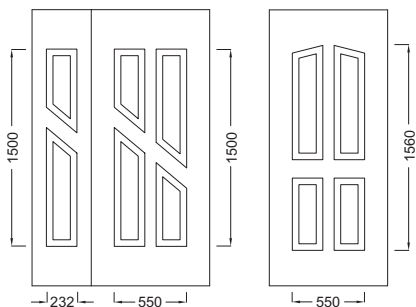

E2000 Series



E905 Vitro 3

E900 Vitro 3



E905 Καράβολο/Karavolo

E900 Καράβολο/Karavolo



Ασφάλεια 1/Safety 1



Ασφάλεια 2/Safety 2



E900 Deco 2



E902



Καίτη/Transom



Αμμοβολή σχέδιο
Sandblasting with
design



E900 Deco 1

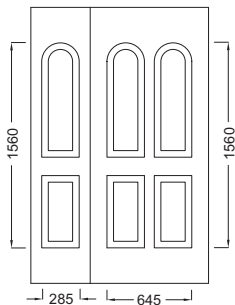

E2000 Series



E905 Ασφάλεια 1/Safety 1

E911 Ασφάλεια 1/Safety 1



E911 Ασφάλεια 2/Safety 2



E910

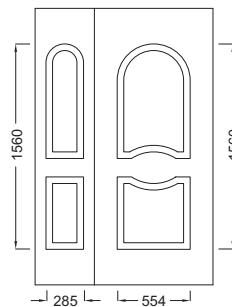



E934 Ασφάλεια 1/Safety 1

E928 Ασφάλεια 1/Safety 1



E928 Ασφάλεια 2/Safety 2



E926

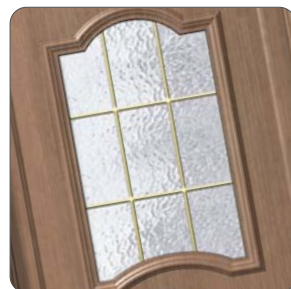

Καίτη/Transom



Καίτη/Transom Inox

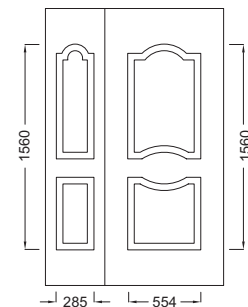

E2000 Series



E943 Ασφάλεια 1/Safety 1



E943 Ασφάλεια 3/Safety 3



E941



Καίτη/Transom

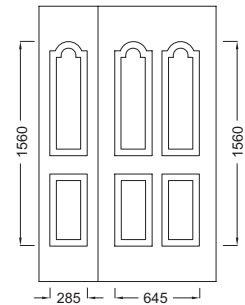



E922



E924

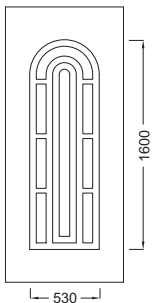

E2000 Series



E960 Vitro 1



E958



E957



E952 Καίτι/Transom Inox



E951



Καίτι/Transom



E954 Fused 2

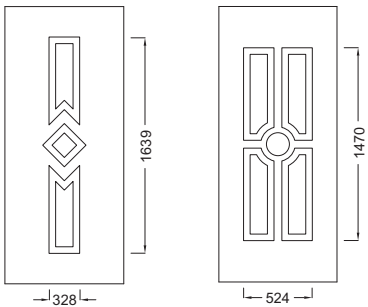

E2000 Series



E988 Vitro 1



E983 Vitro 1

E988 Fused 1

E983 Fused 1



Fused 2



Fused 3

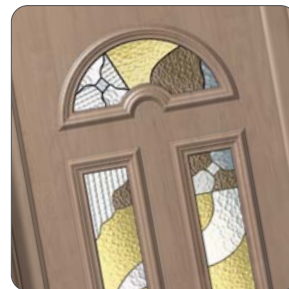

Vitro 2



Deco 1



E983 Ασφάλεια 1/Safety 1



E982



E983 Καίτι/Transom



E981 Καίτι Inox
Transom Inox



E983 Καράβολο/Karavolo

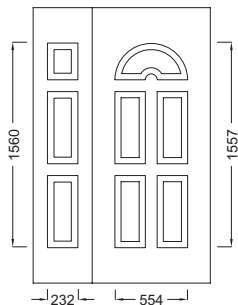

E2000 Series



E210



E200 E212 Ασφάλεια 1/Safety 1

E204 Ασφάλεια 1/Safety 1



Vitro 1

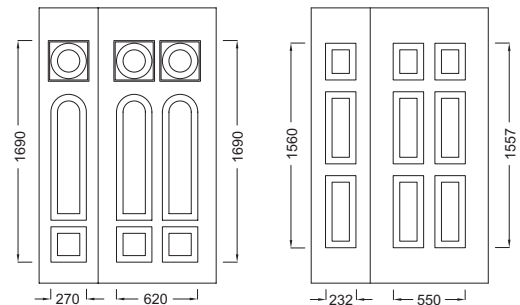



E986

E990



E988 Καΐτι/Transom

E994 Καΐτι/Transom

P6000 Series

Heavy Duty



P6110



P6150



**ΒΑΡΕΩΣ
ΤΥΠΟΥ
HEAVY DUTY
1,5mm**

Ασφάλεια | Security

- Ασφάλεια
- Στιβαρή κατασκευή βαρέως τύπου με ενισχυμένα φύλλα αλουμινίου 1,5mm
- Εξωτερικό πάτημα με ενσωματωμένο ταμπλά αλουμινίου
- Τζάμια διπλής υάλωσης με triplex τζάμι ασφαλείας
- Αυξημένη θερμομόνωση & ηχομόνωση
- Αναλλοίωτες και πιστοποιημένες βαφές και αποχρώσεις ξύλου

- Safety and protection
- Heavy duty pressed aluminium panel 1.5mm thickness
- Double glazing with triplex safety glass
- Exceptional heat and sound insulation coefficient
- Certified powder coatings and wood imitation shades

ΠΑΧΟΣ ΦΥΛΛΟΥ ΑΛΟΥΜΙΝΙΟΥ ALUMINIUM SHEET THICKNESS
1,5 mm
ΣΥΝΟΛΙΚΟ ΠΑΧΟΣ ΠΑΝΕΛ TOTAL PANEL THICKNESS
24 mm
ΑΠΟΚΟΛΛΗΣΗ ΚΟΡΝΙΖΑΣ ΑΠΟ ΕΠΙΦΑΝΕΙΑ ΤΟΥ ΠΑΝΕΛ FRAME DETACHMENT FROM PANEL SURFACE
50,02 Pa/mm ²
ΑΠΟΚΟΛΛΗΣΗ ΦΥΛΛΟΥ ΑΛΟΥΜΙΝΙΟΥ ΑΠΟ ΜΟΝΩΤΙΚΟ SHEET DETACHMENT FROM INSULATION MATERIAL
0,488 N/mm ²
ΣΥΝΤΕΛΕΣΤΗΣ ΘΕΡΜΙΚΗΣ ΑΝΤΙΣΤΑΣΗΣ THERMAL RESISTANCE COEFFICIENT
$RD = m^2 * K/W = 0,55$
ΣΥΝΤΕΛΕΣΤΗΣ ΘΕΡΜΙΚΗΣ ΑΓΩΓΙΜΟΤΗΤΑΣ THERMAL CONDUCTIVITY COEFFICIENT
$\lambda d = W/M * K = 0,035$

P6000 Series

Heavy Duty



P6600

P6100



P6601 Καΐτη/Transom

P6101 Καΐτη/Transom



P6101 Ασφάλεια 4/Safety 4

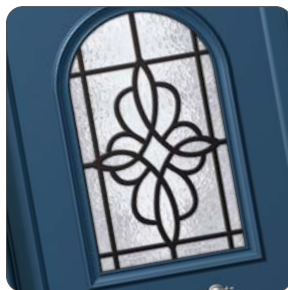

Ασφάλεια 1/Safety 1



P6111 Καίτη/Transom



P6111 Ασφάλεια/Safety 5



P6000 Series

Heavy Duty



P6120



P6121 Ασφάλεια 2/Safety 2



P6121 Καίτη/Transom



P6690

P6190



P6196 Καίτη/Transom



P6196 Ασφάλεια 1/Safety 1



P6000 Series

Heavy Duty



P6630

P6130



P6133 Fused 1



P6632 Kaġtu/Transom

P6133 Kaġtu/Transom



P6752 Fused 4

P6142 Fused 4



P6142 Καίτη/Transom

P6000 Series

Heavy Duty



P6150



P6151 Καίτη/Transom Inox



P6153 Ασφάλεια 1/Safety 1



P6701 Καίτι/Transom

P6201 Καίτι/Transom



P6201 Deco 1

P6000 Series

Heavy Duty



P6740

P6230



P6160



P6741 Ασφάλεια 1/Safety 1

P6231 Ασφάλεια 1/Safety 1



P6161 Ασφάλεια 5/Safety 5



P6161 Ασφάλεια 3/Safety 3



Καΐτι/Transom

P6000 Series

Heavy Duty



P6170



P6171 Καίτη/Transom



P6171 Ασφάλεια 4/Safety 4



P6711

P6221 Καίτι/Transom



P6221 Ασφάλεια 1/Safety 1

P6000 Series

Heavy Duty



P6710

P6210



P6212 Καράβολο/Karavolo



P6212 Ασφάλεια 1/Safety 1



P6212 Καίτι/Transom



P6740

P6240



P6741 Καίτι/Transom Inox

P6242 Καίτι/Transom Inox



P6242 Ασφάλεια 3/Safety 3

P6000 Series

Heavy Duty



P6750

P6250



P6253 Καίτι/Transom



P6251 Καίτι Inox
Transom Inox



P6253 Fused 1



P6253 Ασφάλεια 1/Safety 1



AL 590 Σύστημα κύριας εισόδου

Main entrance door system



1348



Συνολικός Θερμωπαραστάτης
Thermal Insulation Rate

Ud **2,1**
W/(m²·K)



Αντιδερρηκτική Προστασία
Anti-theft Protection

2,0
DIN V ENV 1627

Σημασία στην λεπτομέρεια | Importance to detail



Κλειδαριές με ειδικούς γάντζους στην κάσα που προσφέρουν μέγιστα επίπεδα ασφάλειας και προστασίας. Επιλογή 3 τύπων κλειδαριάς, 3, 5 και 17 σημείων κλειδώματος. Κλειδαριά 3 σημείων που κλειδώνει αυτόματα με το απλό κλείσιμο της πόρτας. Κλειδαριά 17 σημείων που μετατρέπει την κοινή πόρτα σε θωρακισμένη.

Locks with special hooks for maximum security and protection. 4 types available, 3 up to 17 lock points. Automatic 3 point lock that secures when the door closes. 17 point lock that converts a normal door to a security-sealed door.

Κλειδαριές ασφαλείας | Safety locks



Σχεδιασμός συστήματος με σημασία στη λεπτομέρεια, ακόμη και στα σημεία που δεν είναι εύκολα ορατά. Ειδικά πλαστικά εξαρτήματα ένωσης των σημείων, σε αντίθεση με τις συνηθισμένες πόρτες που δεν μπορούν να καλύψουν τις σχεδιαστικές ατέλειες.



System design with importance to detail, even at non-visible points. Special plastic accessories for section joining, unlike normal doors that can't hide any design defects.

Σύστημα δακτυλικού αποτυπώματος | Finger scanner system



Επιλογή ανοίγματος της πόρτας με δακτυλικό αποτύπωμα. Καλαίσθητο και διακριτικό εξάρτημα που ταιριάζει σε οποιονδήποτε χρωματισμό πόρτας. Εύκολος και γρήγορος προγραμματισμός ηλεκτρονικού υπολογιστή με δυνατότητα καταχώρησης έως 100 διαφορετικών δακτυλικών αποτυπωμάτων με κωδικό προστασίας. Άριστης ποιότητας, διακριτικές καλωδιώσεις που διασφαλίζουν την καλή λειτουργία των ηλεκτρονικών κυκλωμάτων.



Door opening through finger scanner. Elegant and discreet component that matches to any door color. Quick and easy computer programming with an entry possibility of up to 100 different finger print security codes. High quality, discreet cables for the normal operation of electronic circuits.

Θερμομόνωση | Thermal insulation

Ο συνδιασμός πάνελ πάχους 38mm, προσφέρει μέγιστη ηχομόνωση και θερμομόνωση καθιστώντας την εξωτερική πόρτα 590 σε θερμομονωτικό σύστημα υψηλών προδιαγραφών.

The use of 38mm thickness panel, offers maximum sound and thermal insulation, making AL590 main entrance door, a system of high specifications.

Προφίλ συστήματος | System profiles

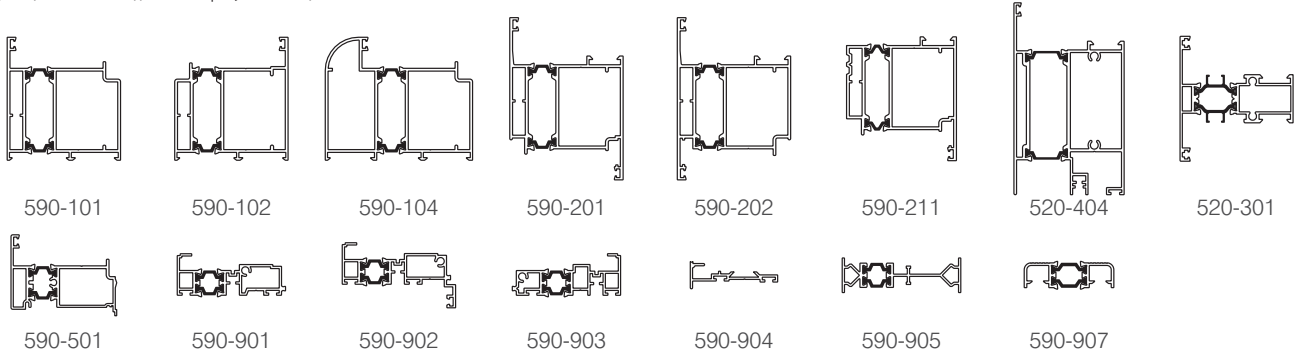

Ταμπλαδάκια / Special size panels

Ειδικά πάνελ για κουζινόπορτες και παραδοσιακά παράθυρα
Special size panels for kitchen doors and windows

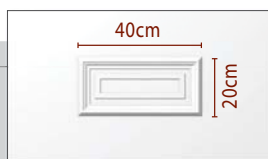

E544 (90x52.5 cm)



E542 (90x210 cm)



E594 (90x210 cm)

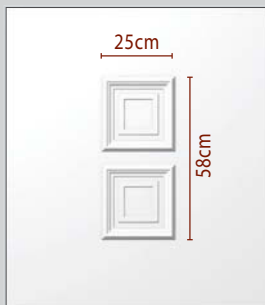

E525 (90x105 cm)



E595 (90x105 cm)



E794 (90x210 cm)

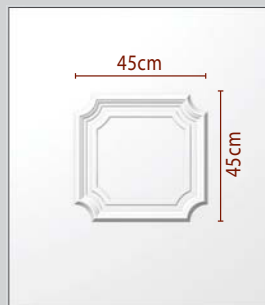

E538 (90x105 cm)

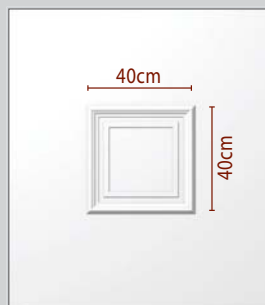

E596 (90x105 cm)

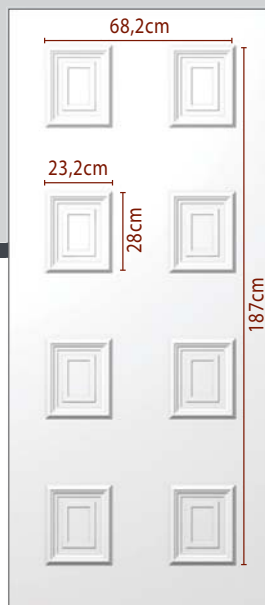

E598 (90x210 cm)

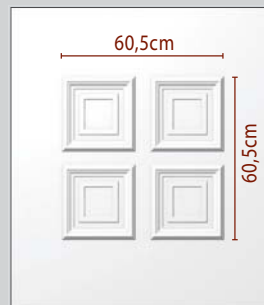

E543 (90x105 cm)



E597 (90x105 cm)

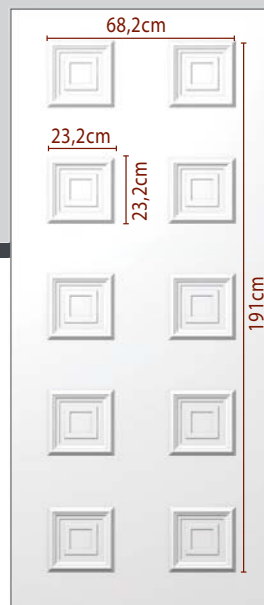

E599 (90x210 cm)

FP-20 Aluplast / PVC

Επίπεδα πάνελ αλουμινίου Aluminium flat panels

- Ενισχυμένη αντοχή σε χτυπήματα
- Σκληρή - Άκαμπτη επιφάνεια
- Αυξημένη Ηχομόνωση
- Ελαφρύ
- Κατάλληλο για ποικίλες εφαρμογές
- Highly resistant material
- Hard, rigid surface
- Increased sound insulation
- Light weight
- Appropriate for various applications

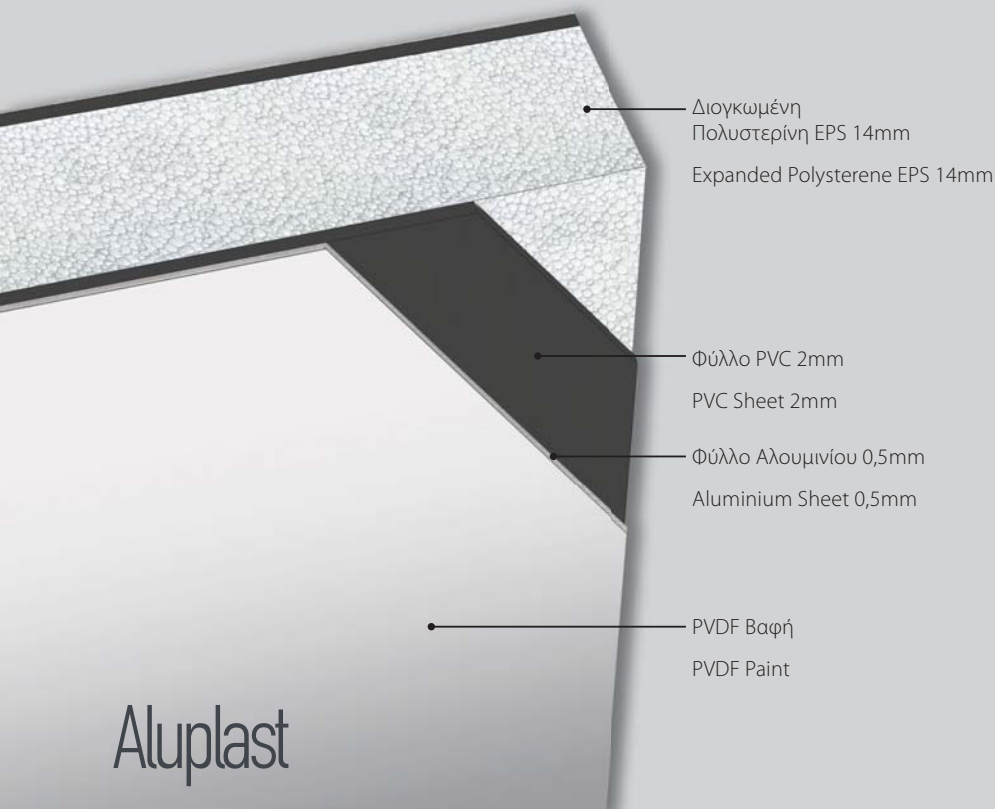

ΣΥΝΟΛΙΚΟ ΠΑΧΟΣ ΠΑΝΕΛ TOTAL PANEL THICKNESS	20mm
ΑΠΟΚΟΛΛΗΣΗ ΦΥΛΛΟΥ ALUMINIUM SHEET DETACHMENT	0,488 N/mm²
ΣΥΝΤΕΛΕΣΤΗΣ ΘΕΡΜΙΚΗΣ ΑΝΤΙΣΤΑΣΗΣ THERMAL RESISTANCE COEFFICIENT	RD=m² * K/W=0,55
ΣΥΝΤΕΛΕΣΤΗΣ ΘΕΡΜΙΚΗΣ ΑΓΩΓΙΜΟΤΗΤΑΣ THERMAL CONDUCTIVITY COEFFICIENT	λD=W/M * K=0,035
ΚΡΑΜΑ ALLOY	AL 3105/H44
ΒΑΦΗ ΕΠΙΦΑΝΕΙΑΣ SURFACE COATING	PVDF, PRIMER
ΠΑΧΟΣ ΑΛΟΥΜΙΝΙΟΥ ALUMINIUM THICKNESS	0,5mm
ΠΑΧΟΣ PVC PVC THICKNESS	2mm
ΠΑΧΟΣ ΠΟΛΥΣΤΕΡΙΝΗΣ POLYSTYRENE THICKNESS	14mm

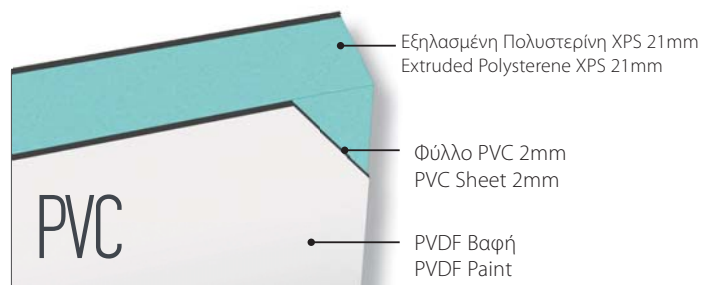

	Code	Dimension
Aluplast	FP090-210/5	900x2100
	FP120-250/5	1200x2500
PVC	FP100-200/7	1000x2000
	FP150-300/7	1500x3000

Χειρολαβές / Handles

Επιλογές απο ποικιλία σχεδίων και υλικών, που συνδυάζονται άψογα με όλες τις πόρτες
 Wide selection of handle designs and materials, to match any type of door

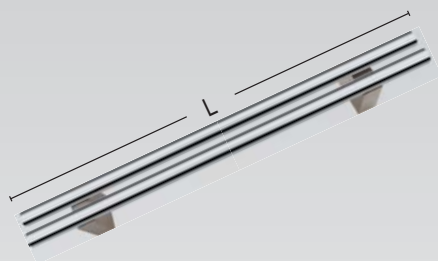

- L40cm 0871X2-040
- L50cm 0871X2-050
- L60cm 0871X2-060
- L80cm 0871X2-080
- L100cm 0871X2-100
- L120cm 0871X2-120
- L150cm 0871X2-150
- L160cm 0871X2-160
- L180cm 0871X2-180
- L200cm 0871X2-200

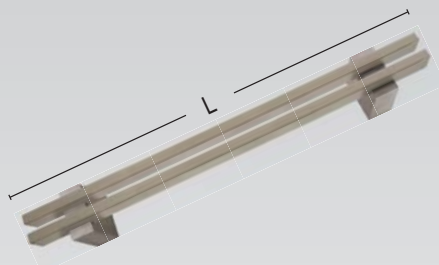

- L40cm 0873X1-040
- L50cm 0873X1-050
- L60cm 0873X1-060
- L80cm 0873X1-080
- L100cm 0873X1-100
- L120cm 0873X1-120
- L150cm 0873X1-150
- L160cm 0873X1-160
- L180cm 0873X1-180
- L200cm 0873X1-200

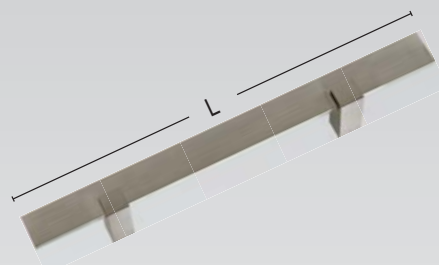

- L40cm 0879X3-040
- L50cm 0879X3-050
- L60cm 0879X3-060
- L80cm 0879X3-080
- L100cm 0879X3-100
- L120cm 0879X3-120
- L150cm 0879X3-150
- L160cm 0879X3-160
- L180cm 0879X3-180
- L200cm 0879X3-200

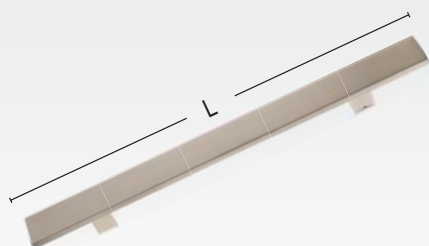

- L40cm 0669X3-040
- L50cm 0669X3-050
- L60cm 0669X3-060
- L80cm 0669X3-080
- L100cm 0669X3-100
- L120cm 0669X3-120
- L150cm 0669X3-150
- L160cm 0669X3-160
- L180cm 0669X3-180
- L200cm 0669X3-200

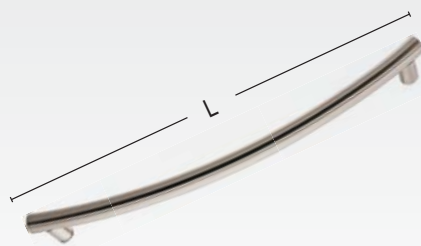

- L45,5cm 0461X3-040
- L65,7cm 0461X3-060
- L85,8cm 0461X3-080
- L105,9cm 0461X3-100

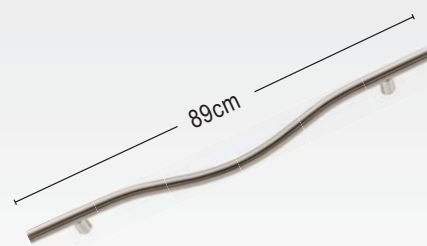

0617X3-089

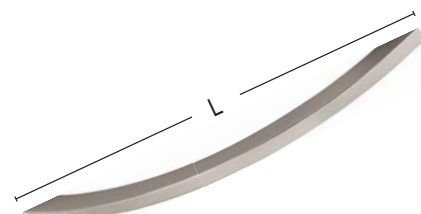

- L30cm 0883X1-025
- L55,5cm 0883X1-050

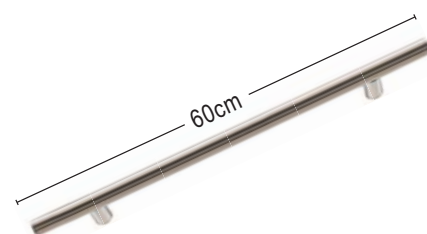

165-500

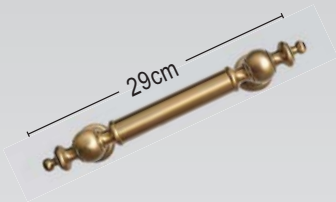

520

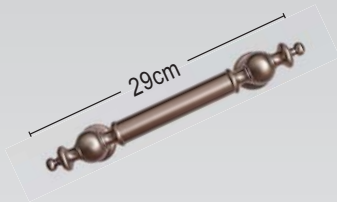

520S

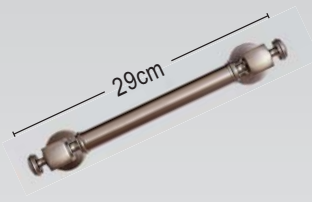

525



102

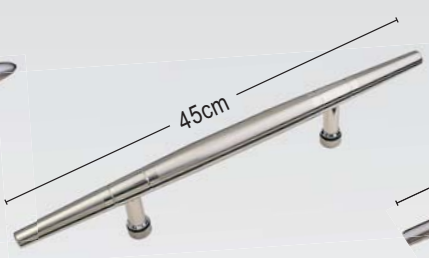

190X1



Inox 190X3
Inox-Glass 190X4



Inox 190X5
Inox-Glass 190X6



Inox 190X7
Inox-Glass 190X8



107



165-400



9cm
Ø50mm 0449P3-005
Ø60mm 0449P3-006
Ø70mm 0449P3-007
Ø80mm 0449P3-008



6,2cm
Ø60mm 0697P4-006
Ø80mm 0697P4-008



6,2cm
60x60mm 0785P4-006
80x80mm 0785P4-008



INOFITA VIOTIA 32011 GREECE

TEL: +30 22620 47000

FAX: +30 22620 47092

mail@aluminco.com

export@aluminco.com

www.aluminco.com



Για να μεταβείτε στο www.aluminco.com
σαρώστε με το barcode scanner του τηλεφώνου
σας για να ακολουθήσετε το σύνδεσμο.

To go to www.aluminco.com simply use your
phone's barcode scanner and follow the link.